

Kit 3072

- CITROËN Berlingo, 4-dr Van, 08-
- CITROËN Berlingo, 5-dr Van, 08-
- PEUGEOT Partner, 4-dr Van, 08-
- PEUGEOT Partner, 5-dr Van, 08-

This Kit is only for vehicles with fixpoint mounting.

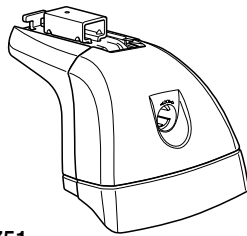

751

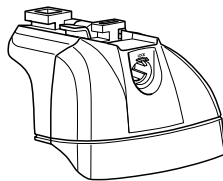
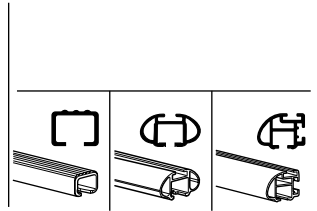

753

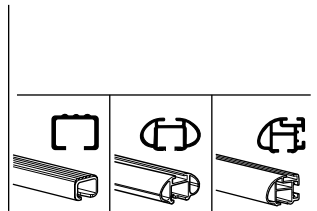

6 kg / 13 lbs + **xx kg** / **xx lbs** = **Max. 100 kg** / **Max. 220 lbs**

9 kg / 20 lbs + **xx kg** / **xx lbs** = **Max. 150 kg** / **Max. 330 lbs**

THULE + **Kit XXXX**

A

B

C

02 x 4

29 x 4

50997 **x 4**

x 1

x 1

x 4

6 mm **x 1**

x 1

Kit

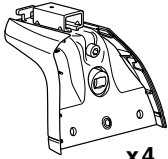
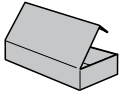

751

x4



x4



x4



12 mm

x8



5 mm

x1



x4



x1

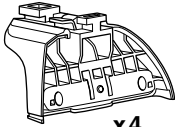

753

x4



x4



x4



16 mm

x8



5 mm

x1



x4



x1

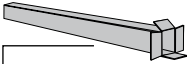

x2



x2

17 mm



x2

23 mm



x2

23 mm



x2

17 mm



x2

23 mm



x2



x2



x2

25 mm



x2



x4



x4



x4



x2

x2

x4

x4



x1

5 mm

1

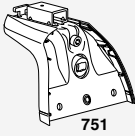

751

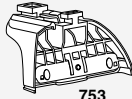

753

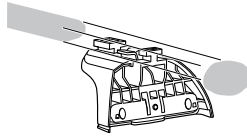
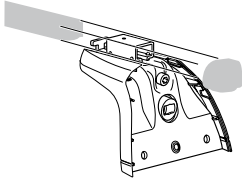

x4

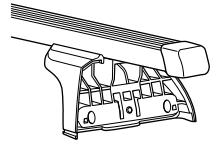
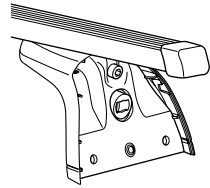
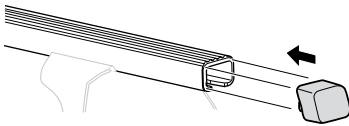

x4

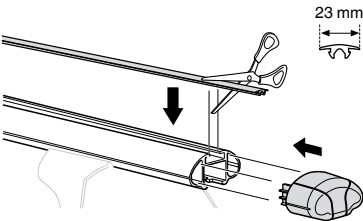

23 mm

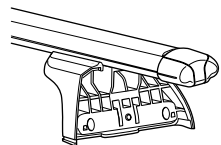
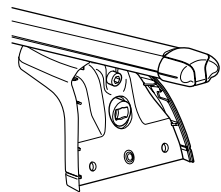
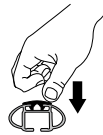



x4

x4

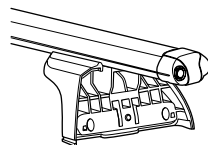
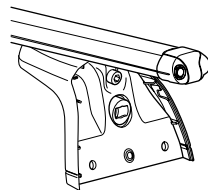
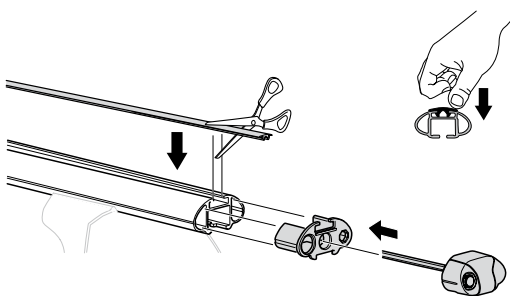

x2

x2

x4

x4

x1
5 mm

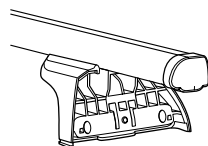
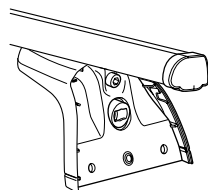
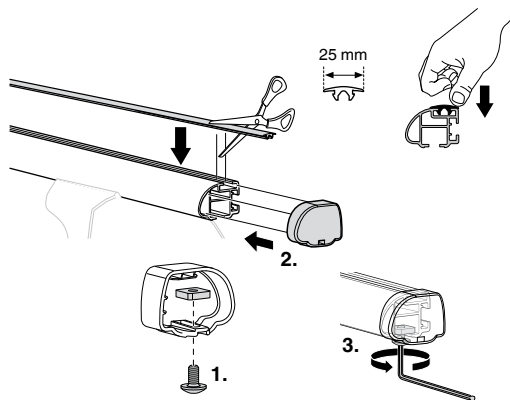

2



02 x 4

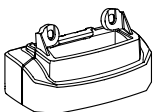

29 x 4



x 4

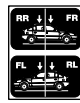

x 1

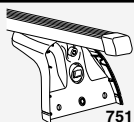

751

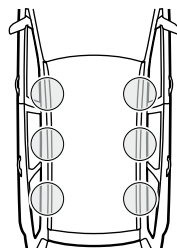
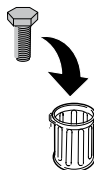
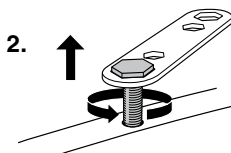
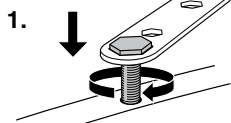
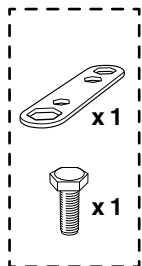
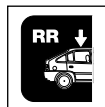
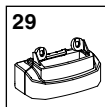
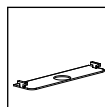
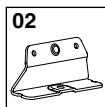
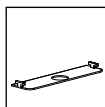
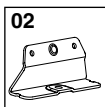
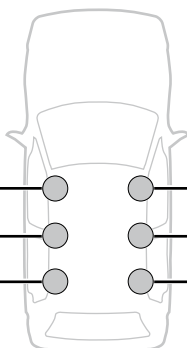
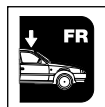
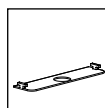
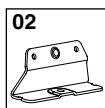
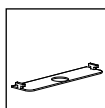
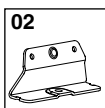
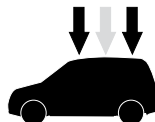

2



02 x 2

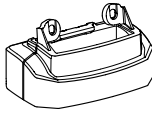

29 x 2

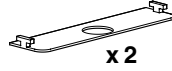

x 2

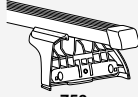

753

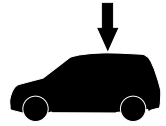

02

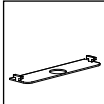

29

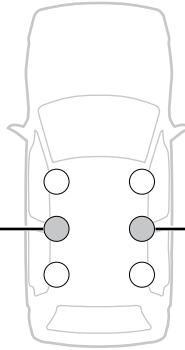

02

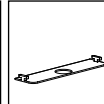

29

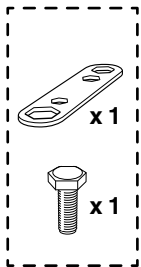

1.

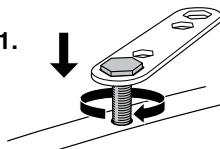

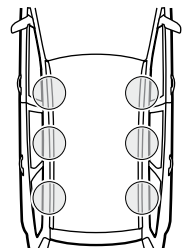
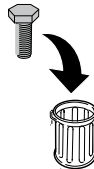
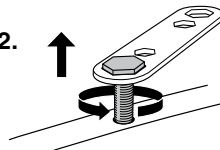

2.

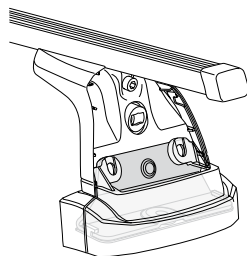
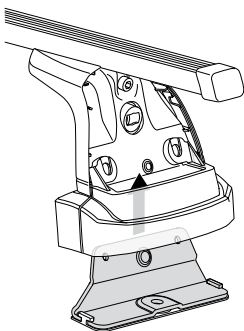
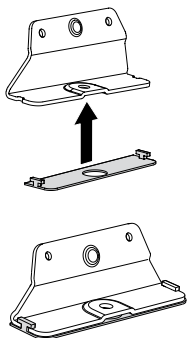
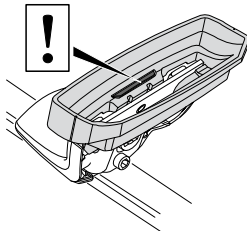
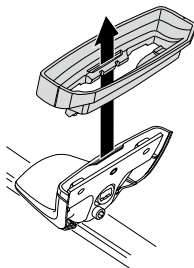
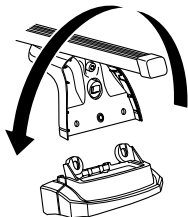
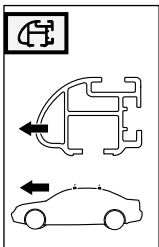
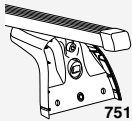

3



12 mm  x 8

5 mm  x 1

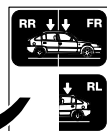
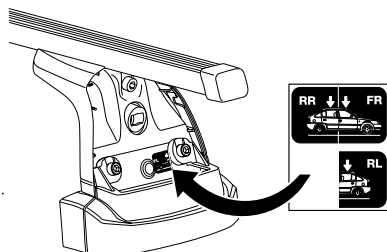
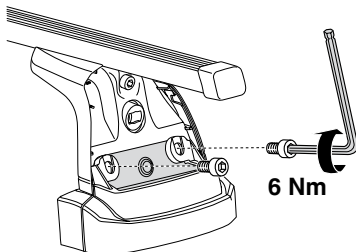

3

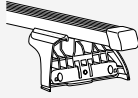

753

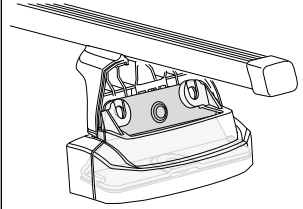
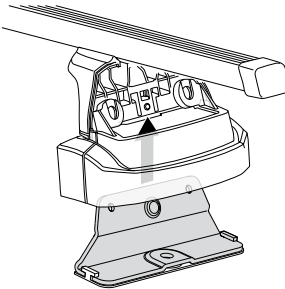
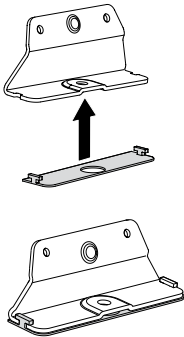
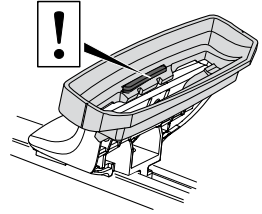
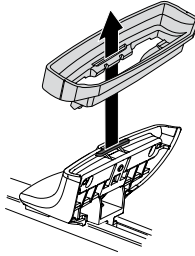
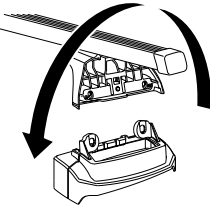
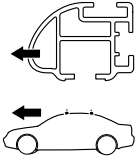

16 mm x 4

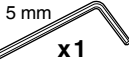

5 mm x 1

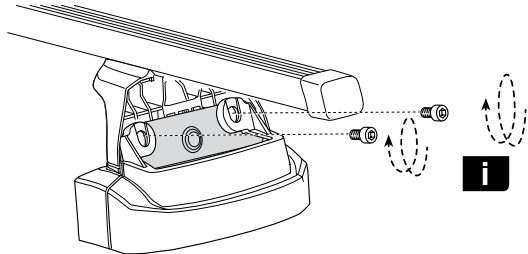

i

GB Only a few turns
D Nur wenige Umdrehungen
F Quelques tours uniquement
NL Slechts enkele slagen
I Solo qualche giro
E Sólo algunas vueltas
PT Noções básicas
S Endast några varv
FIN Vain muutama kierros

EST Ainult mõni pööre
LAT Tikai dažī apgriezieni
LIT Tik keli pasukimai
PL Wystarczy kilka obrotów
RU Достаточно нескольких оборотов
CZ Pouze několik otáčecí
SK Len niekoľko otáčok
SLO Le nekaj obratov

HR Samo nekoliko okreta
HU Csak néhány fordítás
GR Μόνο μερικές στροφές
TR Yalnız birkaç kez çevirm
中文 只有几个转向
한국어 두 세번만
日本語 数回転のみ
ไทย หมุนเพียงไม่กี่รอบ

4

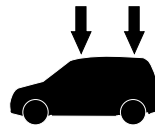
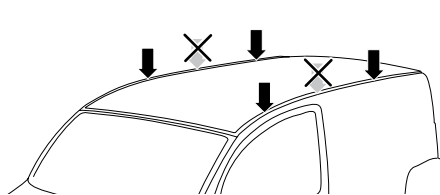
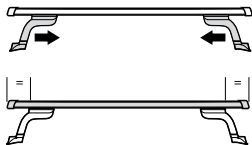
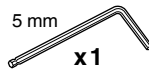
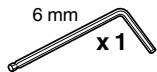

A

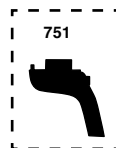
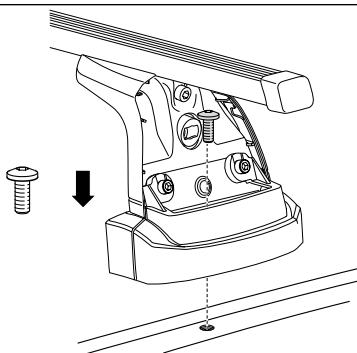

B

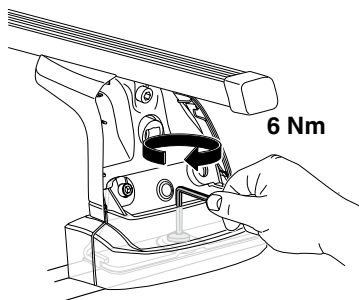

C

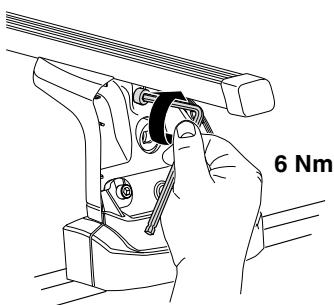

4

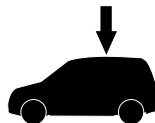
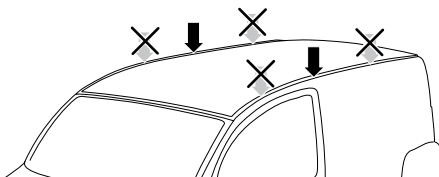
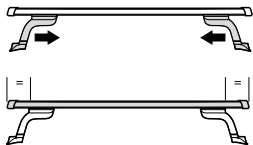
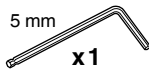
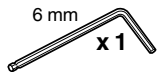

A

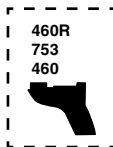
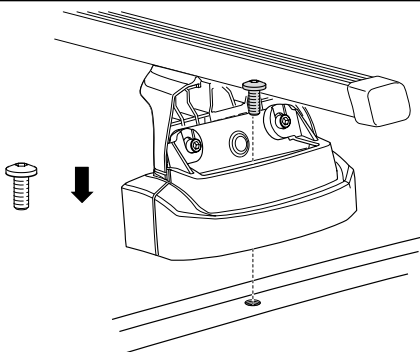

B

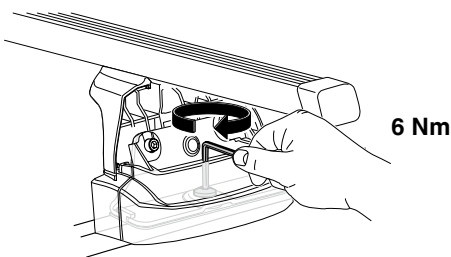

C

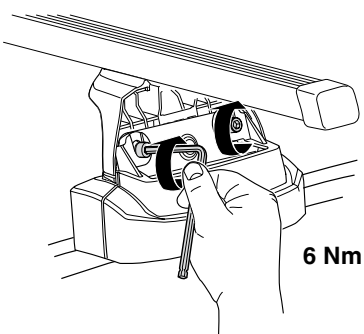

5



751

x4



x4



x1



753

x4



x4



x1

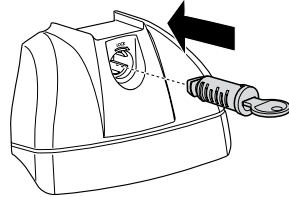
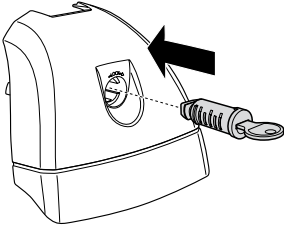

6

5 mm

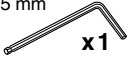

x1

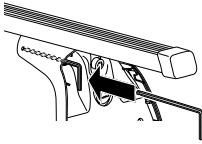

751

x4

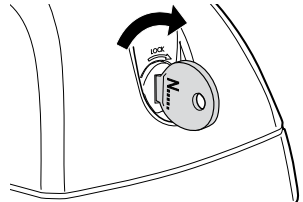
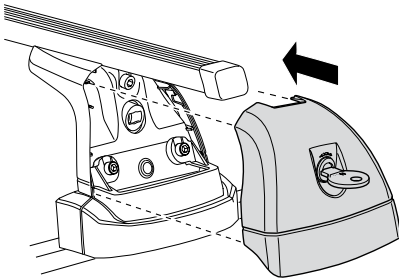

753

x4

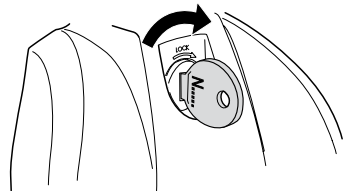
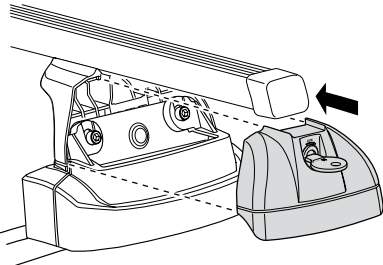

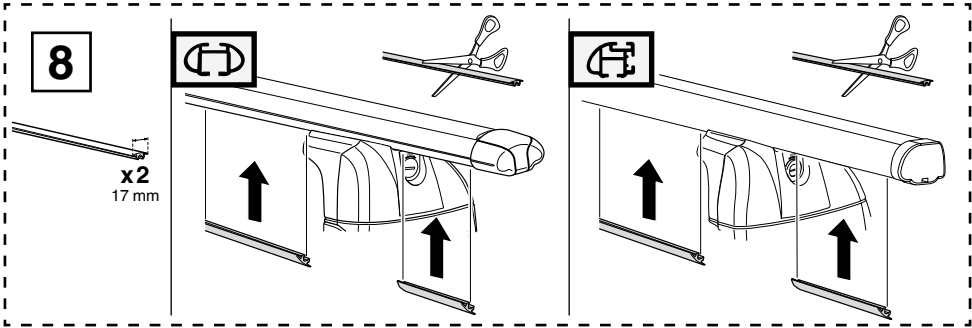
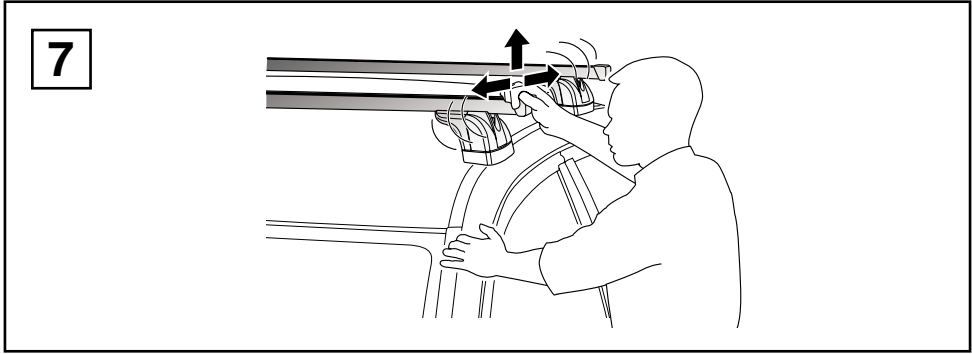

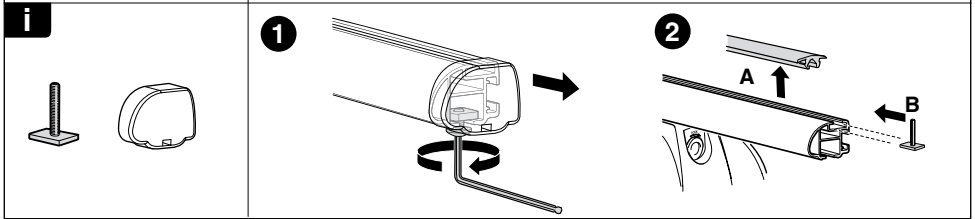
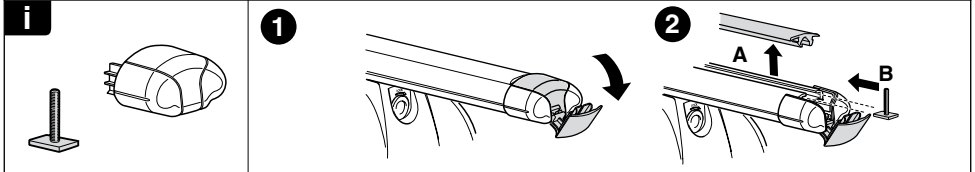
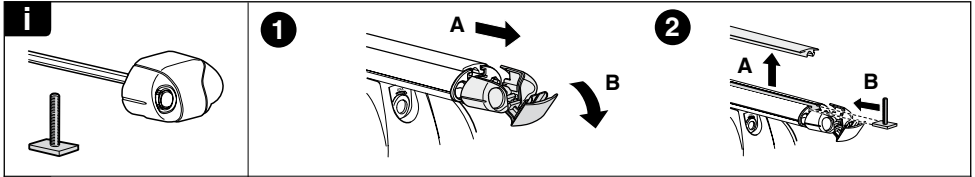
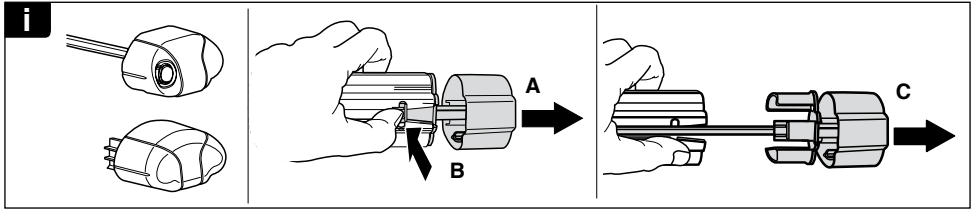



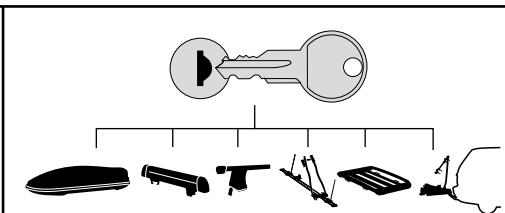

THULE
SWEDEN
**ONE
KEY
SYSTEM**



-  **544** (x4)
 -  **596** (x6)
 -  **588** (x8)
 -  **510** (x10)
 -  **452** (x12)
- NA
EUR
ASIA