

Kit 3011

PEUGEOT 607, 4-dr Sedan, 99-10

This Kit is only for vehicles with fixpoint mounting.

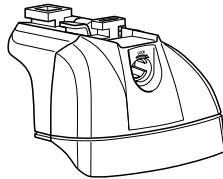

460R
753

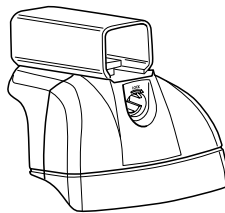
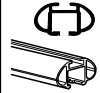

460

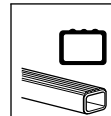

- 50865 54 mm x 4
- 50866 57,5 mm x 4
- 50784 x 8
- 50786 x 8
- 50861 x 1
- 02 x 2
- 03 x 2
- 29 x 2
- 30 x 2
- RR ↓ FR
- FL ↓ RL
- x 1

Kit

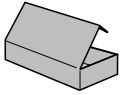

753

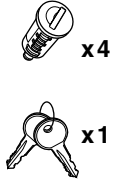
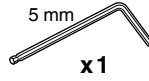
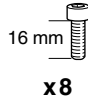
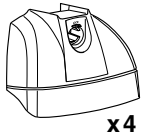
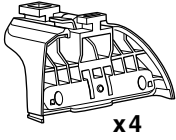

460R

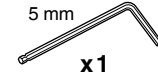
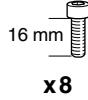
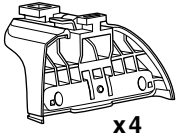

460

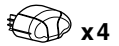
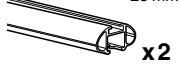
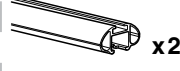
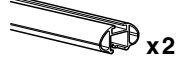
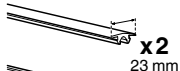
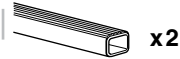
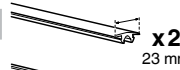
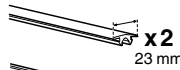
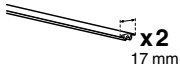
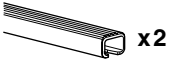
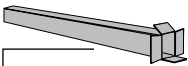
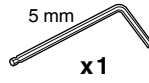
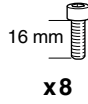
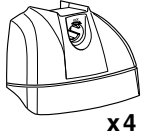
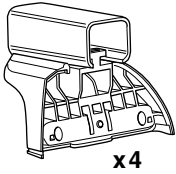

1

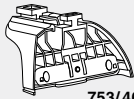

753/460R

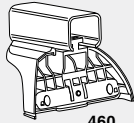

460

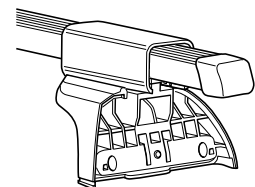
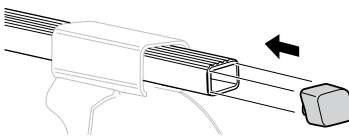
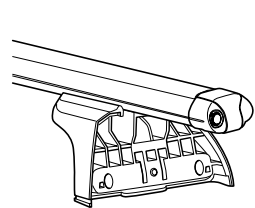
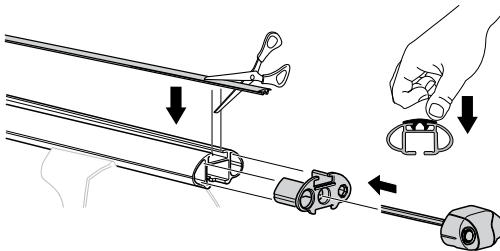
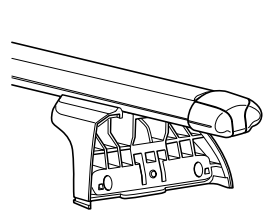
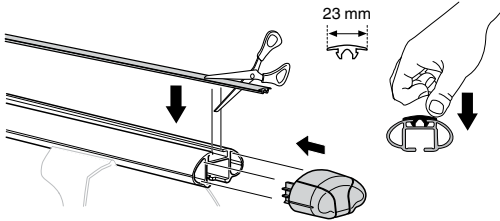
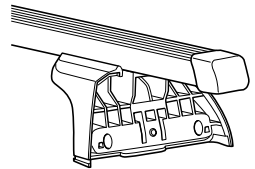
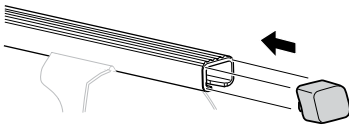
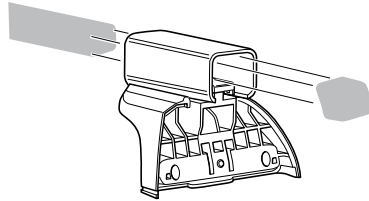
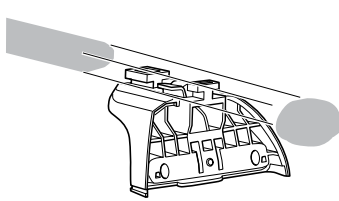

2

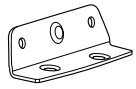

02 x 2



29 x 2

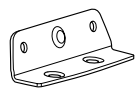
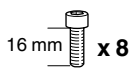

03 x 2

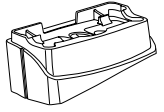

30 x 2

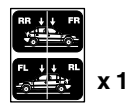

x 1

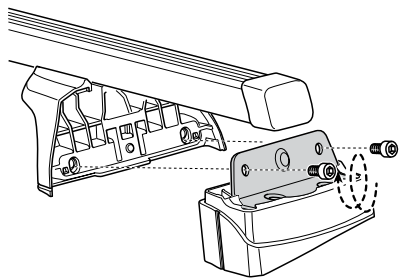
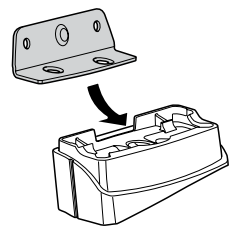
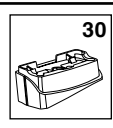
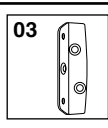
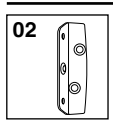
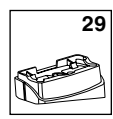
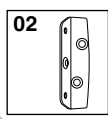
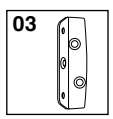

i

- GB** Only a few turns
- D** Nur wenige Umdrehungen
- F** Quelques tours uniquement
- NL** Slechts enkele slagen
- I** Solo qualche giro
- E** Sólo algunas vueltas
- PT** Noções básicas
- S** Endast några varv
- FIN** Vain muutama kierros

- EST** Ainult mõni pööre
- LAT** Tikai dažī apgriezieni
- LIT** Tik keli pasukimai
- PL** Wystarczy kilka obrotów
- RU** Достаточно нескольких оборотов
- CZ** Pouze několik otáček
- SK** Len niekoľko otáčok
- SLO** Le nekaj obratov

- HR** Samo nekoliko okreta
- HU** Csak néhány fordítás
- GR** Μόνο μερικές στροφές
- TR** Yalnız birkaç kez çevirm
- 中文** 只有几个转向
- 한국어** 두 세번만
- 日本語** 数回転のみ
- ไทย** หมุนเพียงไม่กี่รอบ

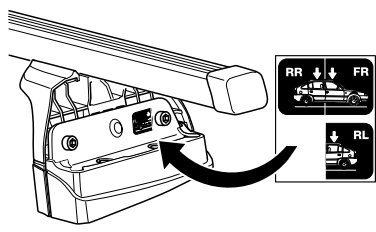

3

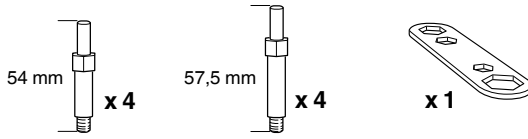

A

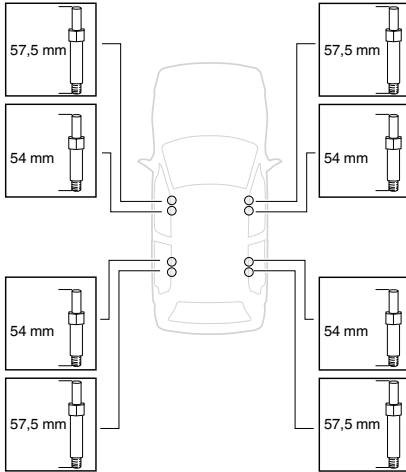

B

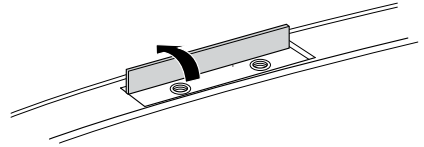

C

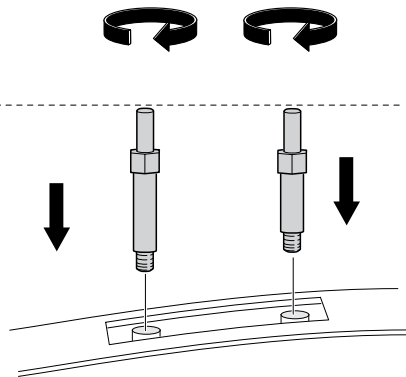

D

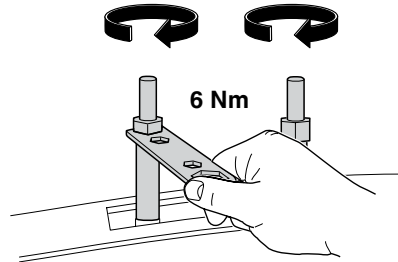

4

 **x8**

 **x8**

x1

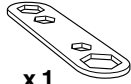

A

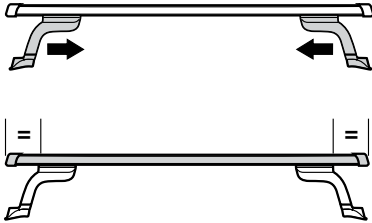

B

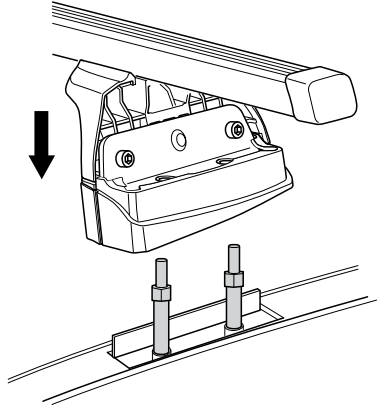

C



D

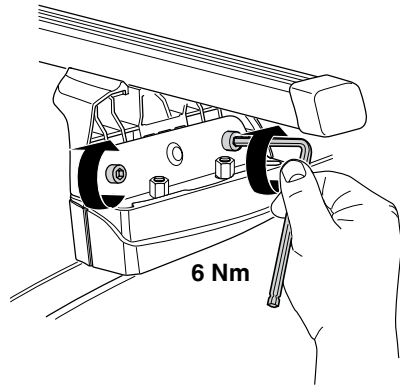

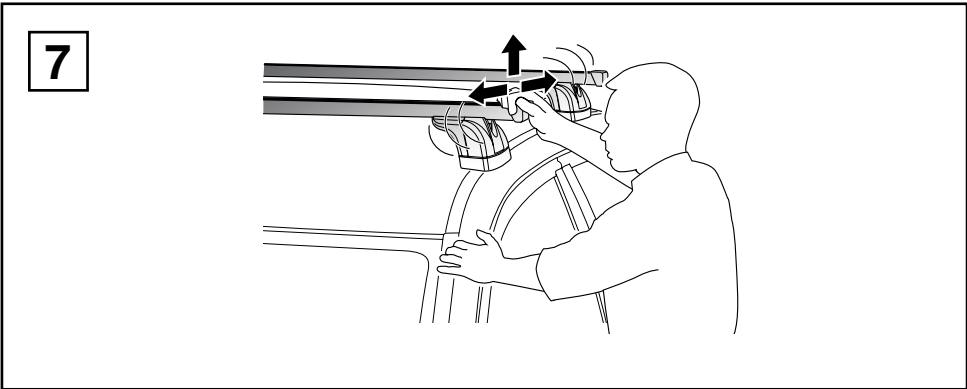
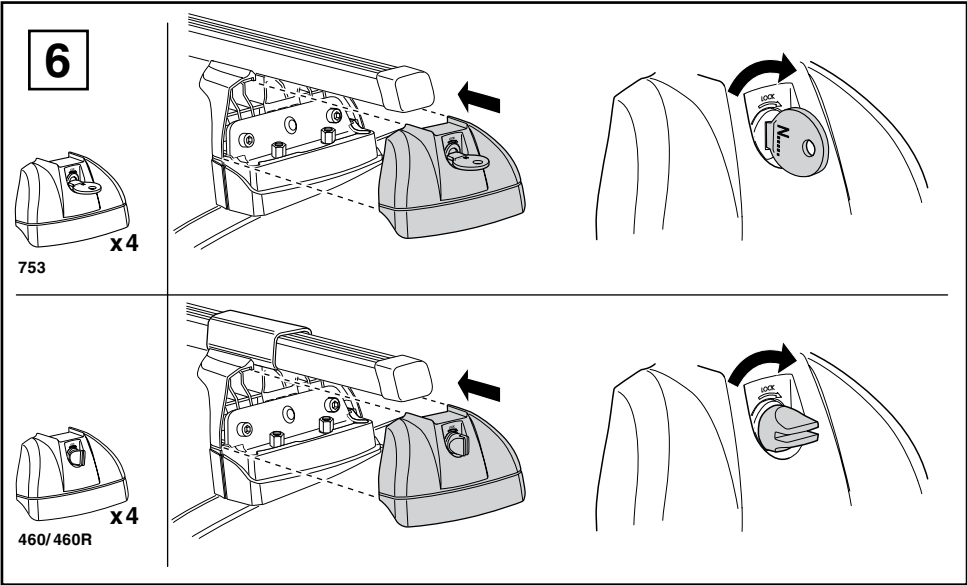
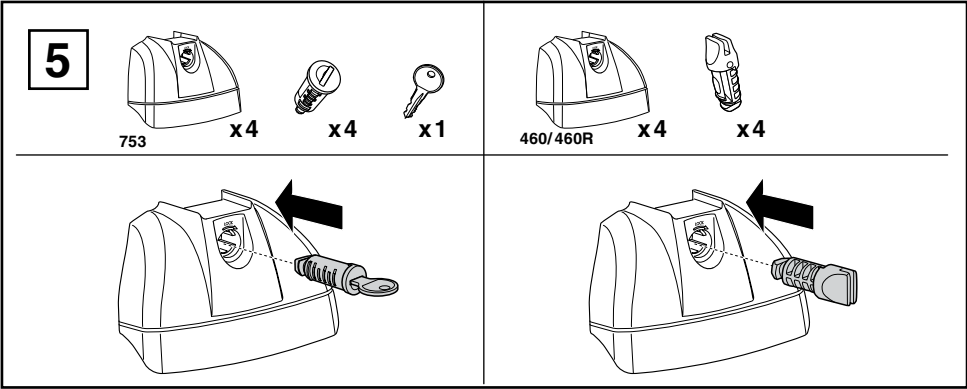

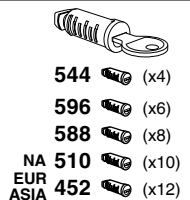
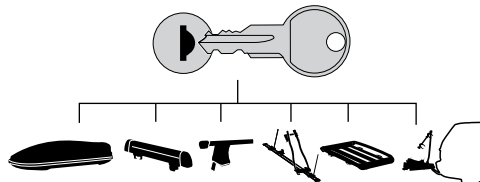
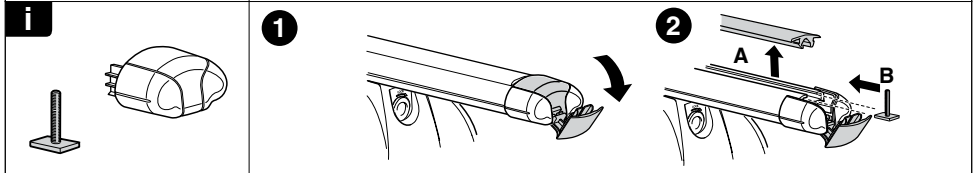
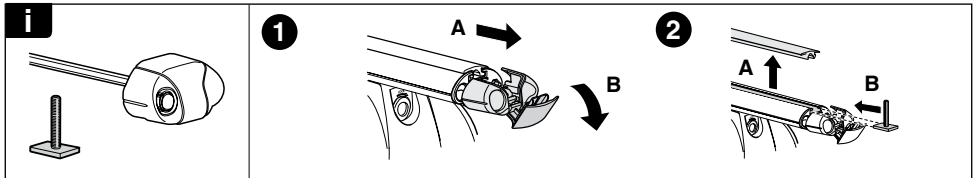
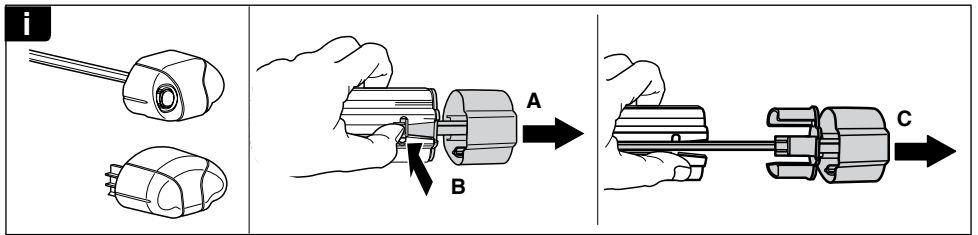
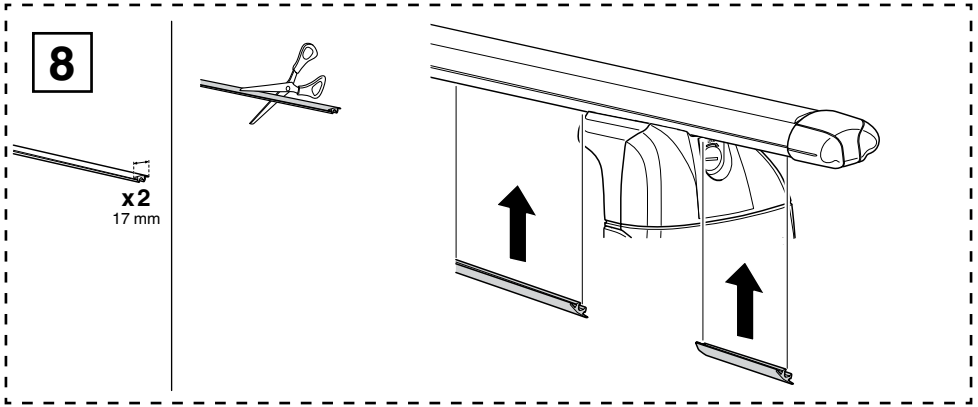

WW ▶ Thule Sweden AB, Box 69, 330 33 Hillerstorp, SWEDEN

NA ▶ Thule Inc., 42 Silvermine Road, Seymour, Connecticut 06483, USA

@ info@thule.com
customer.service@thule.com

www.thule.com

506-3011-02