

Kit 1713

SKODA Rapid, 5-dr Hatchback, 13-
SEAT Toledo, 5-dr Hatchback, 13-

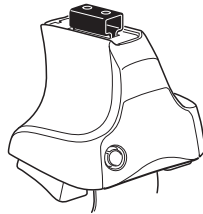

754 Rapid System
480R Rapid Traverse (North America)

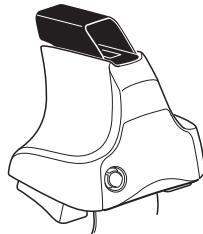
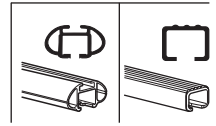

480 Traverse (North America)

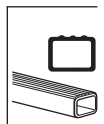

- 754 Rapid System: x1 (box), x4 (cubes), x4 (754 Rapid Traverse (North America) units), x4 (screws)
- 480R Rapid Traverse (North America): x1 (ruler), x4 (480R Rapid Traverse (North America) units), x4 (screws), x4 (cubes)
- 480 Traverse (North America): x1 (ruler), x4 (480 Traverse (North America) units), x4 (screws), x4 (cubes)

- 23 mm bars: x2 (short), x2 (long)
- 17 mm bars: x1 (short), x2 (long)
- Hardware: x4 (screws), x4 (nuts), x2 (washers), x2 (brackets)
- (North America): x2 (short bars), x2 (long bars), x2 (brackets)

- 1251: x4
- 217: x2
- 363: x1
- 378: x1
- FR/FL/RL/RR labels: x1

1

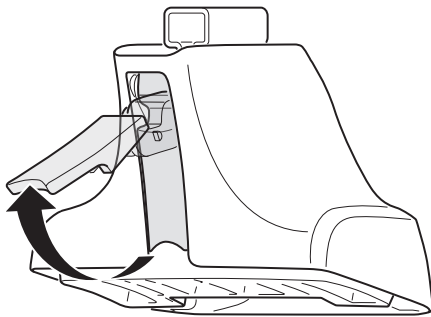

2



754 Rapid System
480R Rapid Traverse
(North America)

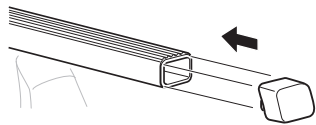
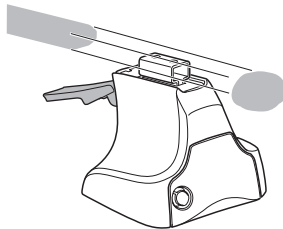

x4



10 mm

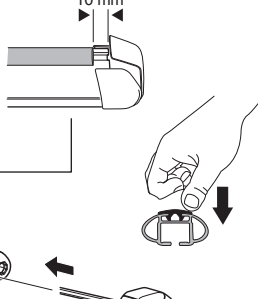

x4



10 mm

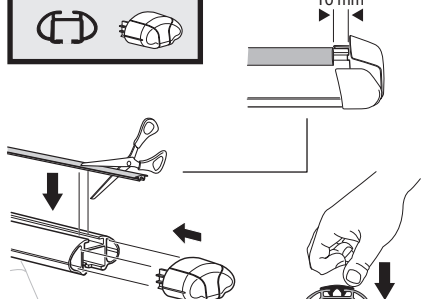

x4



480 Traverse
(North America)

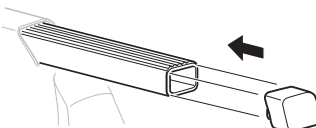
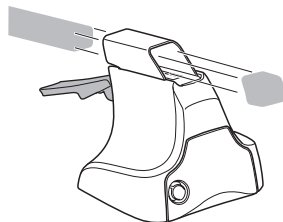

x4

3

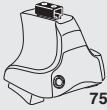

754 Rapid System

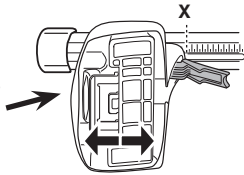

X

SKODA Rapid, 5-dr Hatchback, 13-	41
SEAT Toledo, 5-dr Hatchback, 13-	41

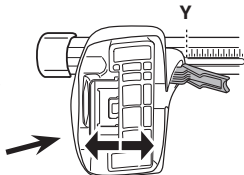

Y

SKODA Rapid, 5-dr Hatchback, 13-	38,5
SEAT Toledo, 5-dr Hatchback, 13-	38,5

3



480R Rapid Traverse



480 Traverse



(North America)

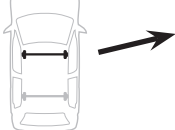

X inch **X mm**

SKODA Rapid, 5-dr Hatchback, 13-	41 3/4"	1061 mm
SEAT Toledo, 5-dr Hatchback, 13-	41 3/4"	1061 mm

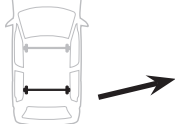

Y inch **Y mm**

SKODA Rapid, 5-dr Hatchback, 13-	40 3/4"	1036 mm
SEAT Toledo, 5-dr Hatchback, 13-	40 3/4"	1036 mm

4

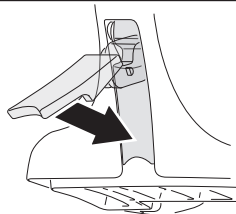

5

SKODA Rapid, 5-dr Hatchback, 13–
SEAT Toledo, 5-dr Hatchback, 13–

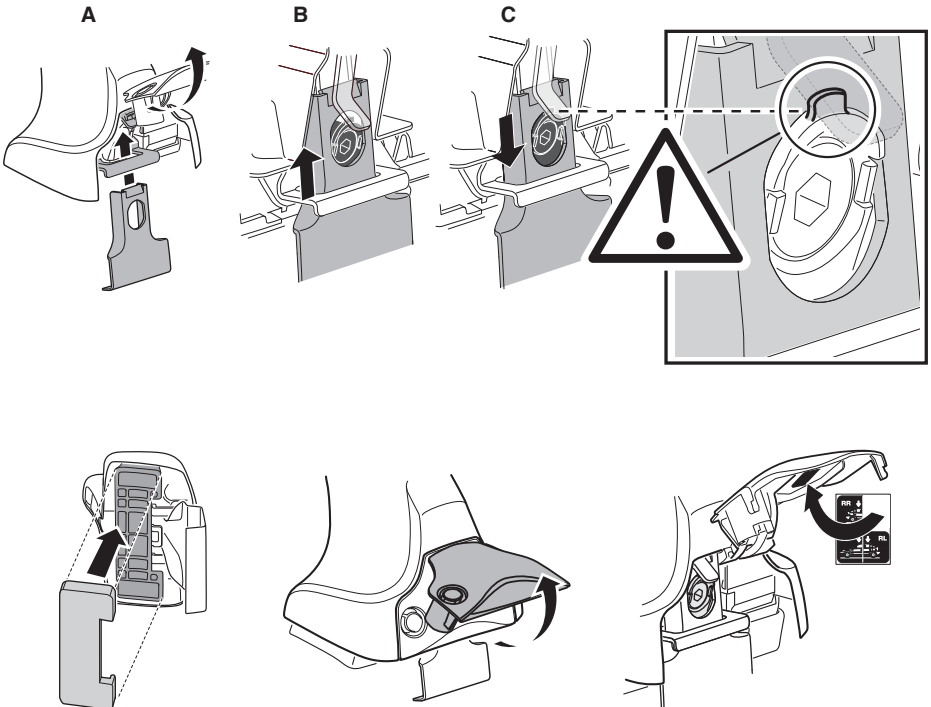
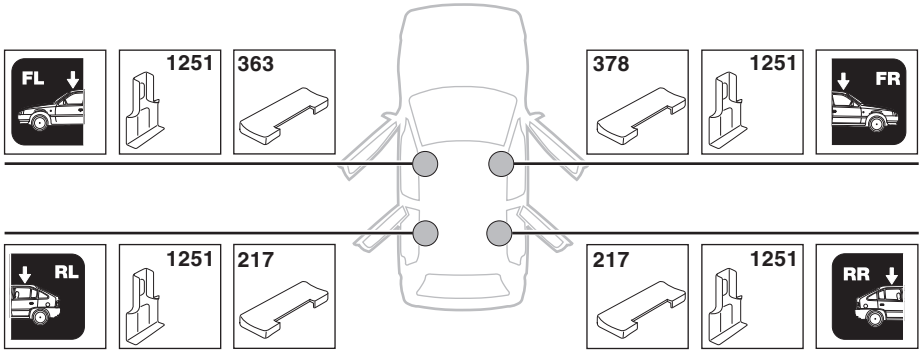

6

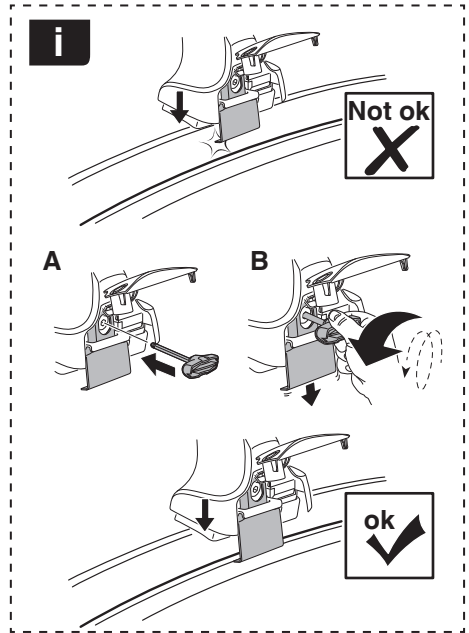
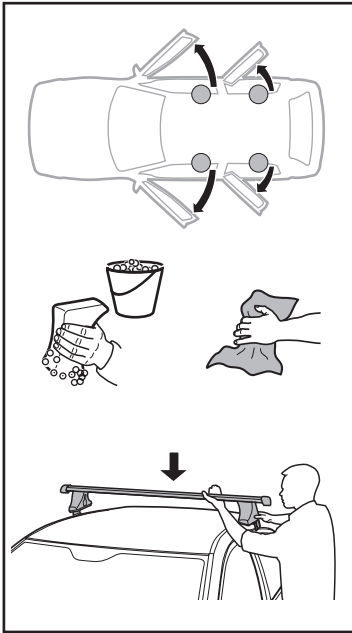

	X mm	Y mm	X inch	Y inch
SKODA Rapid, 5-dr Hatchback, 13-	175 mm	715 mm	6 ⁷ / ₈ "	28 ¹ / ₈ "
SEAT Toledo, 5-dr Hatchback, 13-	175 mm	715 mm	6 ⁷ / ₈ "	28 ¹ / ₈ "

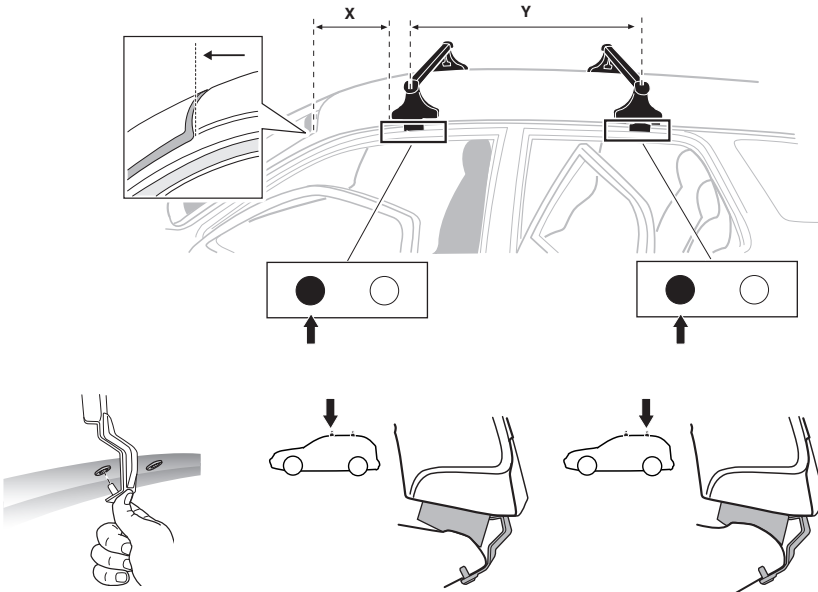

7

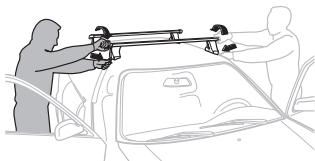

GB/US Tighten alternately
 D Die Schrauben abwechselnd anziehen
 F Serrer alternativement chaque côté
 NL Afwisselend aan de linker- en de rechterkant aandraaien
 I Alternare il serraggio delle viti
 E Apretar alternativamente
 PT Aperte alternadamente
 S Dra åt växelvis
 FIN Kierrä vuorotellen
 EST Pinguldage vaheldumisi
 LAT Pieļieciet pamišus
 LIT Užsukinėkite pakaitomis
 PL Śruby dokręcaj naprzemiennie
 RU Затягивайте попеременно

CZ Pokręťta bagażnika dokręcaj dokręcaj naprzemiennie.
 SK Dofahajte striedavo
 SLO Privijajte izmenično.
 HR Naizmjenočno zategnite
 HU Egymástól függetlenül szorítandó
 GR Σφιγγείτε εναλλάξ
 TR Dönüşümlü sıkın

中文 交替拧紧

한국어 번갈아 가며 조이십시오.

日本語 交互に締め付けてください。

ไทย ชันในแบบสลับ

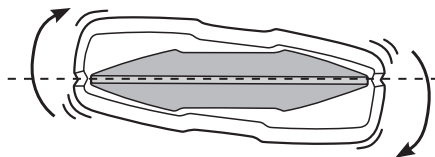
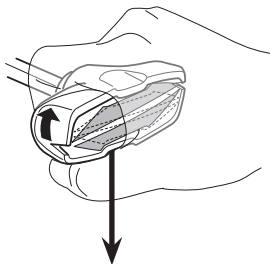
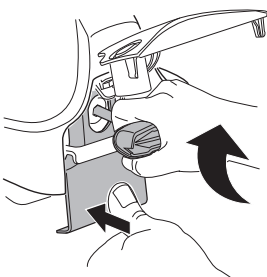
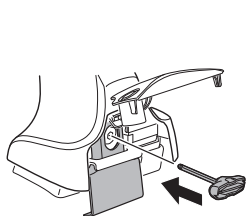

≈ 3 Nm

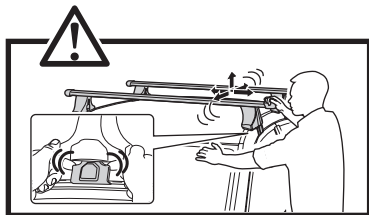
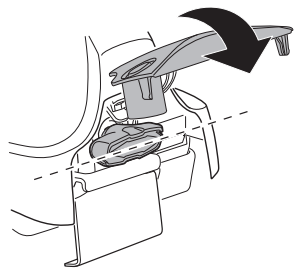

8



x1
17 mm

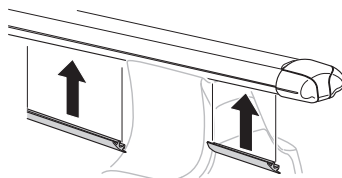
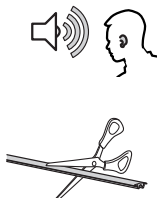

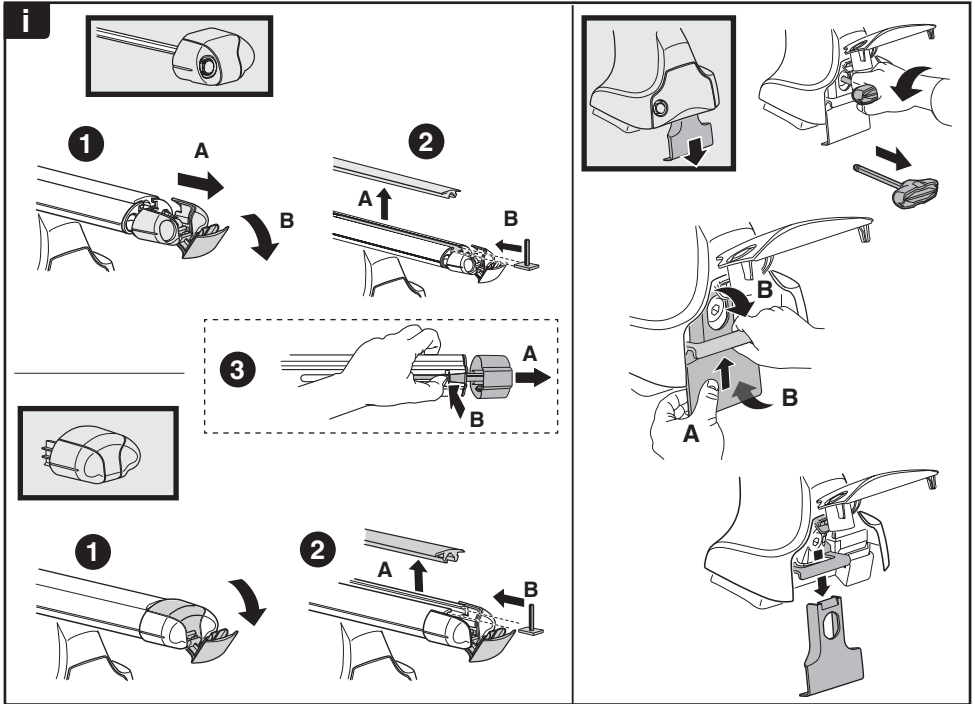
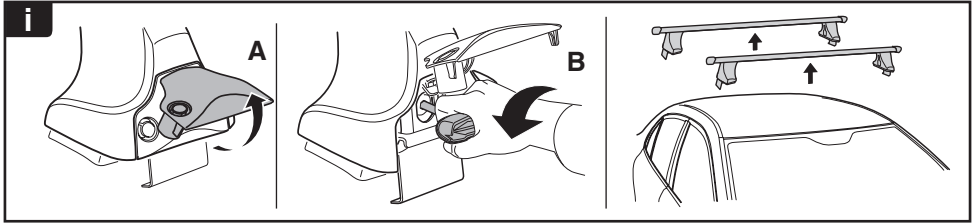

THULE
SWEDEN
**ONE
KEY
SYSTEM**

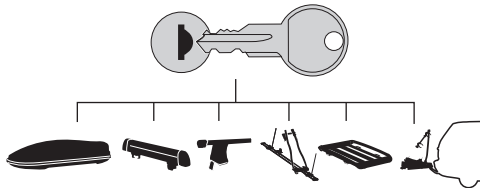

544 (x4)

596 (x6)

588 (x8)

NA **510** (x10)

EUR **452** (x12)

ASIA

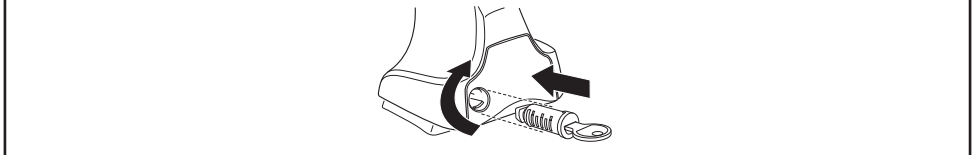

WW ▶ Thule Sweden AB, Box 69, 330 33 Hillerstorp, SWEDEN
NA ▶ Thule Inc., 42 Silvermine Road, Seymour, Connecticut 06483, USA

@ info@thule.com
customer.service@thule.com

www.thule.com

503-1713-02