

Kit 1664

HONDA Civic, 5-dr Hatchback, 12 –

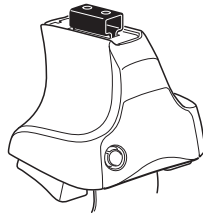

754 Rapid System
480R Rapid Traverse (North America)

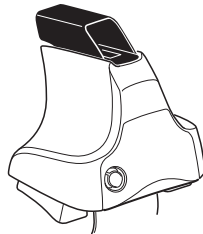
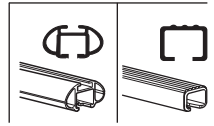

480 Traverse (North America)

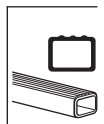

754 Rapid System
480R Rapid Traverse (North America)

754 Rapid System
480R Rapid Traverse (North America)
480 Traverse (North America)

(North America)

1100 x 2
1206 x 2
348 x 1
349 x 1
383 x 1
384 x 1
x 1

1

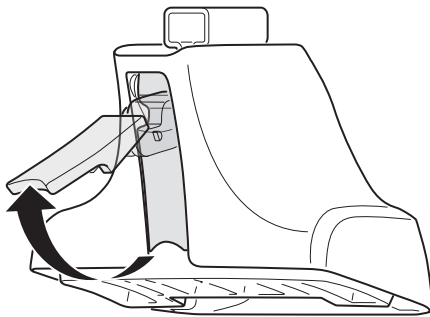

2



754 Rapid System
480R Rapid Traverse
(North America)

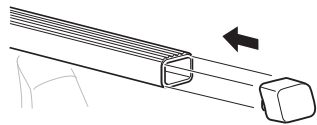
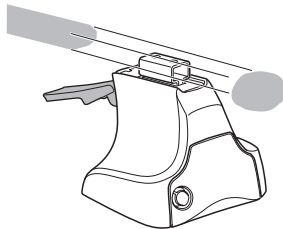

x4

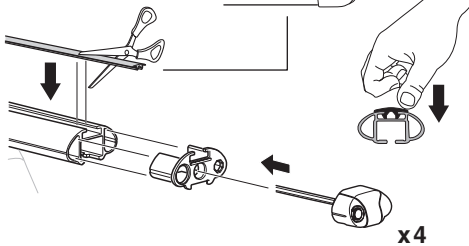
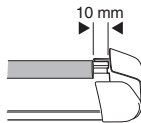

x4

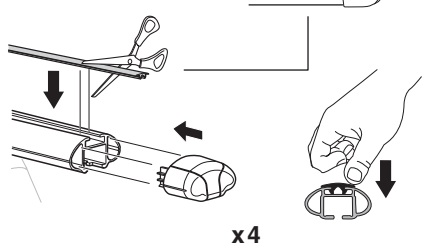
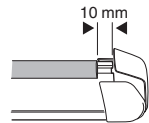

x4



480 Traverse
(North America)

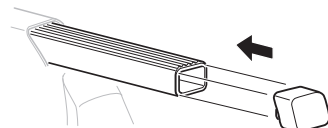
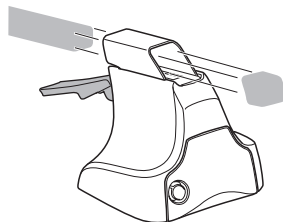

x4

3

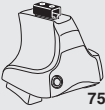

754 Rapid System

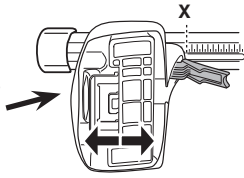

	X
HONDA Civic, 5-dr Hatchback, 12 -	42

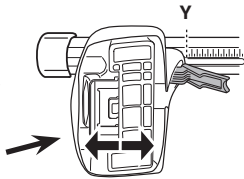

	Y
HONDA Civic, 5-dr Hatchback, 12 -	32,5

3



480R Rapid Traverse



480 Traverse



(North America)

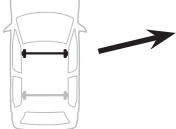

	X inch	X mm
HONDA Civic, 5-dr Hatchback, 12 -	42 1/8"	1071 mm

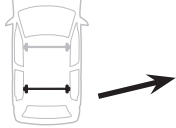

	Y inch	Y mm
HONDA Civic, 5-dr Hatchback, 12 -	38 3/8"	976 mm

4

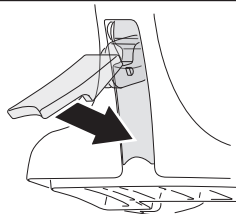

5

HONDA Civic, 5-dr Hatchback, 12-

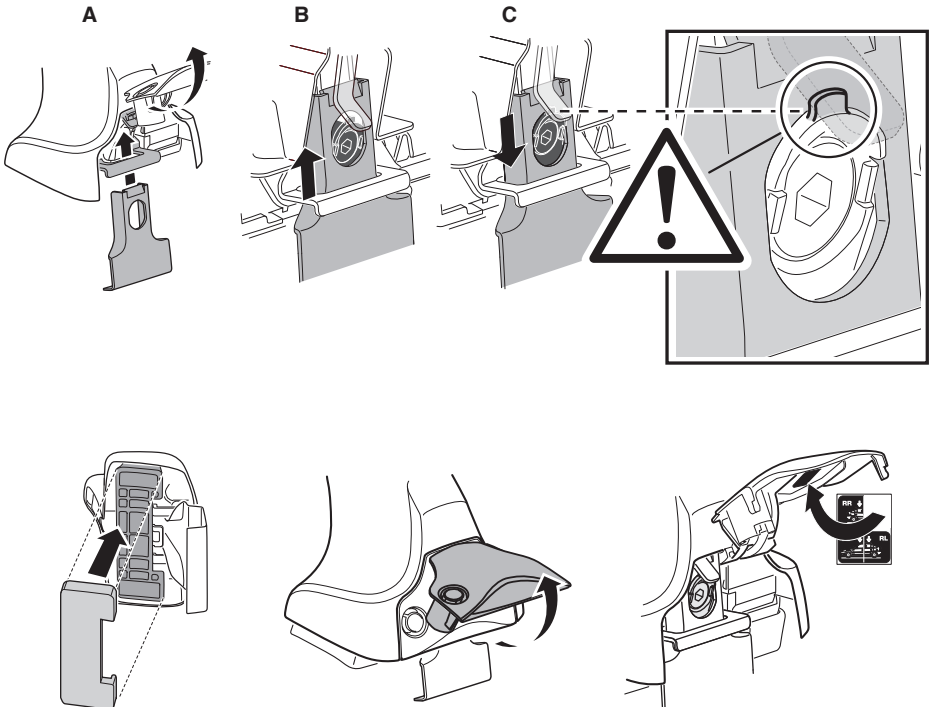
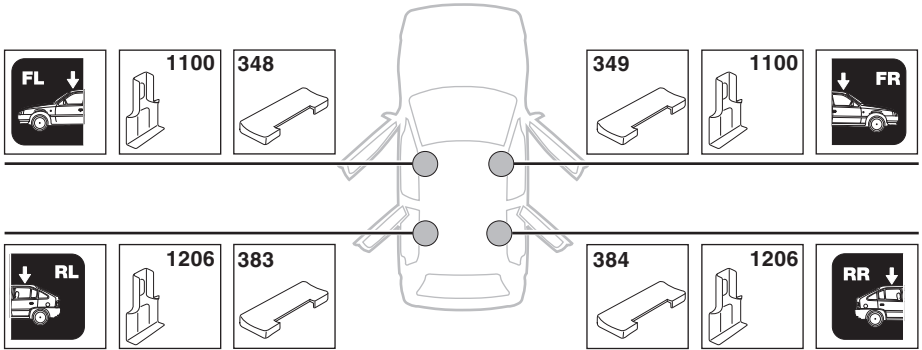

6

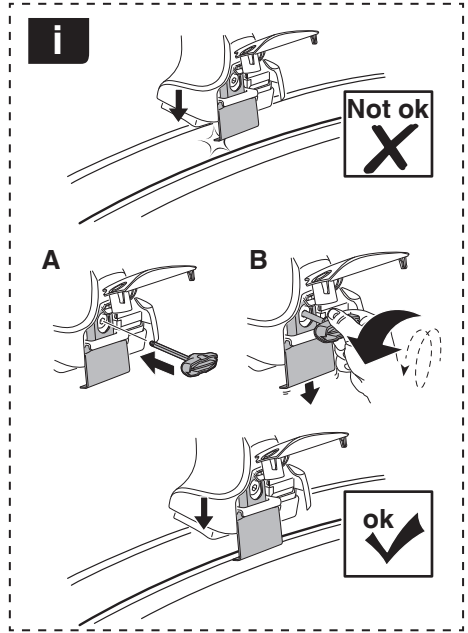
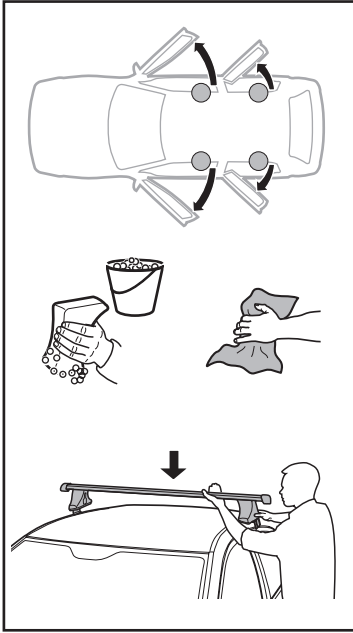

HONDA Civic, 5-dr Hatchback, 12 -

X mm	Y mm	X inch	Y inch
220 mm	650 mm	8 5/8"	25 5/8"

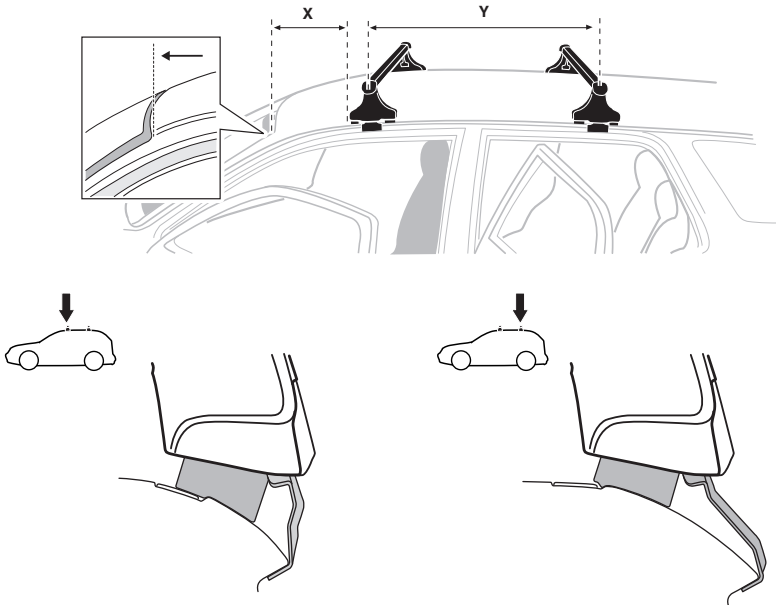

7

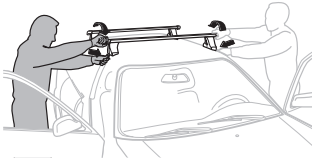

- EN Tighten alternately
- DE Die Schrauben abwechselnd anziehen
- FR Serrer alternativement chaque côté
- NL Afwisselend aan de linker- en de rechterkant aandraaien
- IT Alternare il serraggio delle viti
- ES Apretar alternativamente
- PT Aperte alternadamente
- SV Dra åt växelvis
- DK Spænd skiftevis
- NE Trekk til vekselvis
- FI Kierrä vuorotellen
- ET Pinguldage vaheldumisi
- LV Pievelciet pamišus
- LT Užsukinėkite pakaitomis
- PL Śruby dokręcaj naprzemiennie

- RU Затягивайте попеременно
- UK Затягти по чергово
- BG Затегнете последователно
- CS Pokręťta багаžníka dokręcaj dokręcaj naprzemiennie.
- SK Dotiahujte striedavo
- SL Privijajte izmenično.
- HR/BIH Naizmjenično zategnite
- HU Egymástól függetlenül szorítandó
- EL Σφίγγετε εναλλάξ
- TR Dönüşümlü sıkın

إحكام الربط بالتناوب
התקנת לסיבובי HE

- ZH 交替拧紧
- JA 自動固定
- KO 번갈아 조이기
- TH ชั่งน้ำหนักสลับ

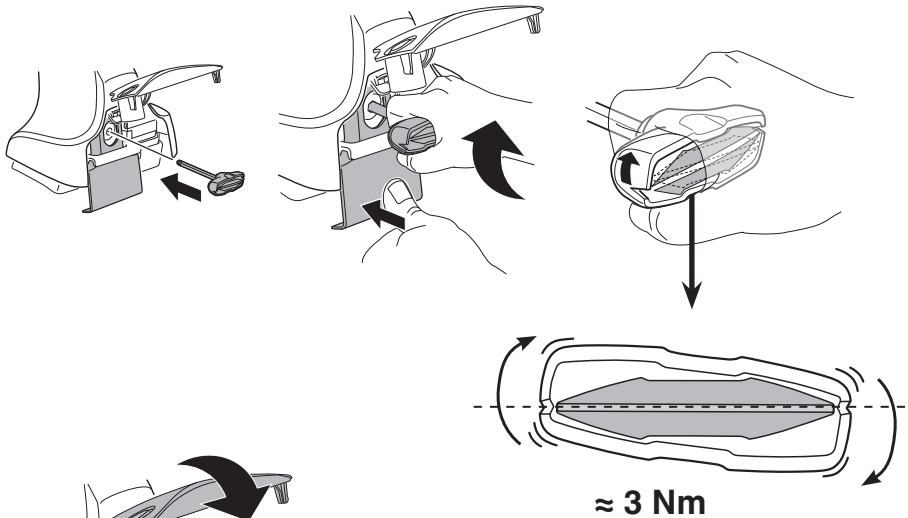

≈ 3 Nm

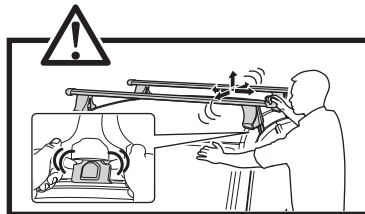

8



x1
17 mm

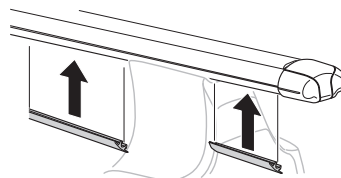
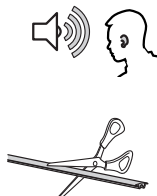

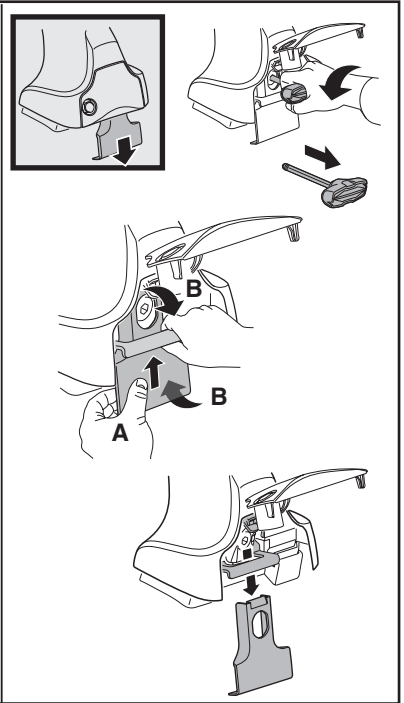
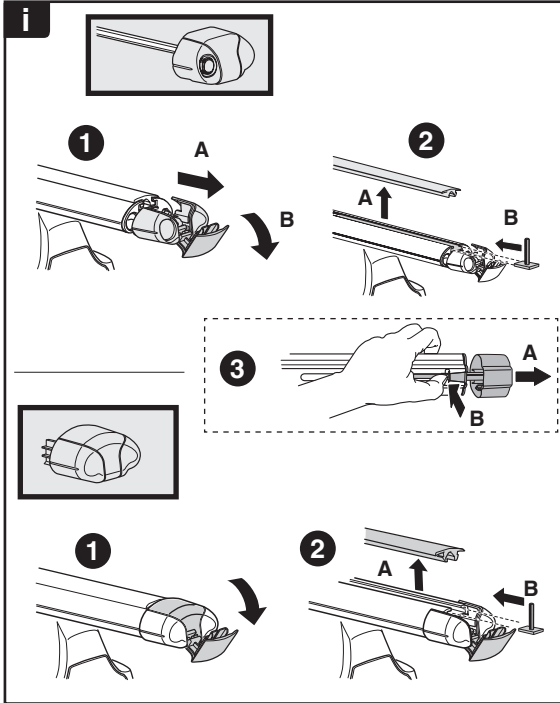
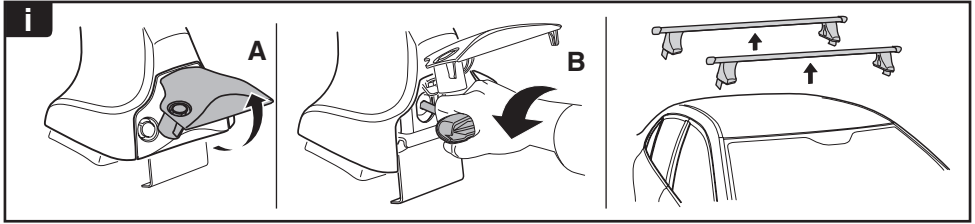

THULE
SWEDEN
**ONE
KEY
SYSTEM**

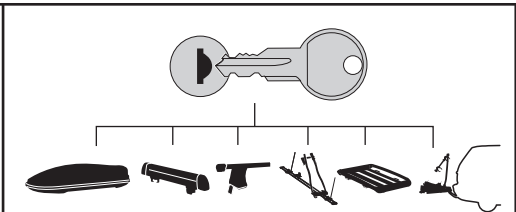

		(x4)
		(x6)
		(x8)
NA		(x10)
EUR		(x12)
ASIA		

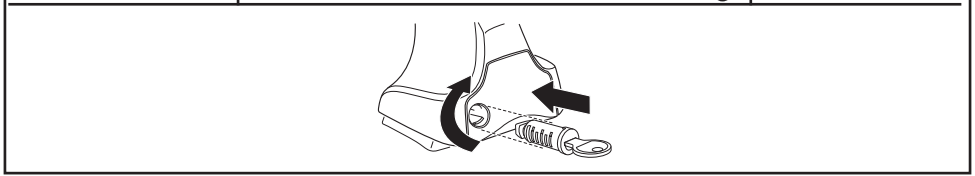

WW ▶ Thule Sweden AB, Box 69, 330 33 Hillerstorp, SWEDEN
NA ▶ Thule Inc., 42 Silvermine Road, Seymour, Connecticut 06483, USA

info@thule.com
customer.service@thule.com

www.thule.com