

Kit 1602

BMW X1, 5-dr SUV, 10- (Without railing)

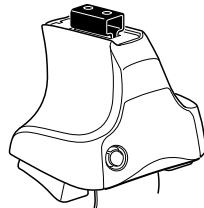

480R Rapid Traverse
754 Rapid System

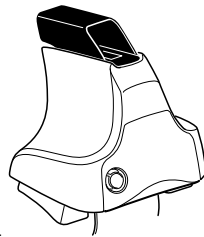
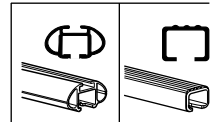

480 Traverse

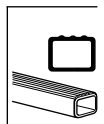

Kit

1



480R Rapid Traverse
754 Rapid System



480 Traverse

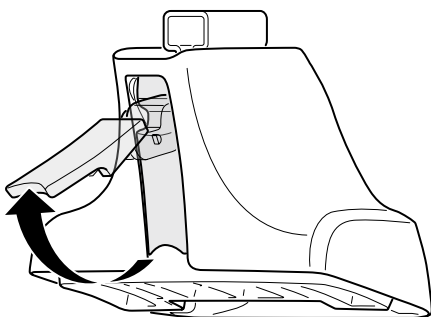

2

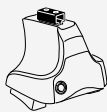

480R Rapid Traverse
754 Rapid System



480 Traverse

+

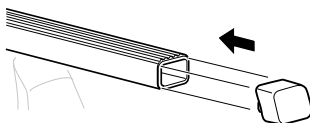
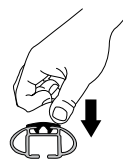
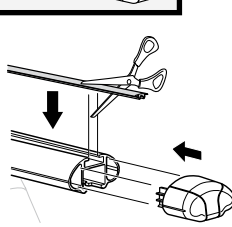
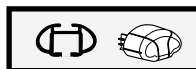
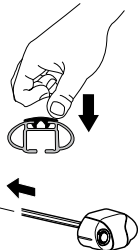
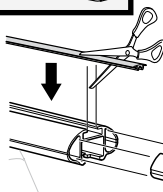
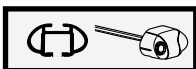
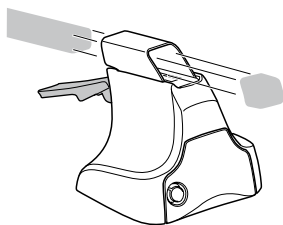
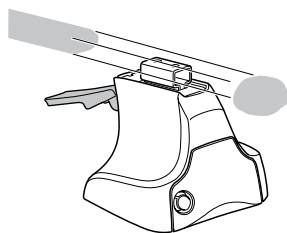

3

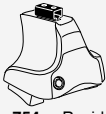

754 Rapid System

1

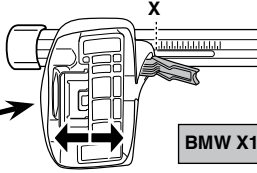
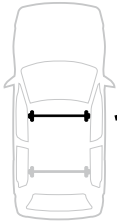

2

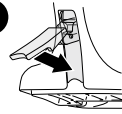

	X
BMW X1, 5-dr SUV, 10- (Without railing)	41,5

1

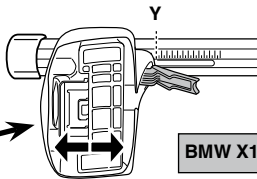
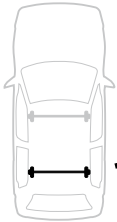

2

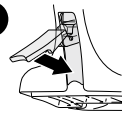

	Y
BMW X1, 5-dr SUV, 10- (Without railing)	40,5



480R Rapid Traverse



480 Traverse

1

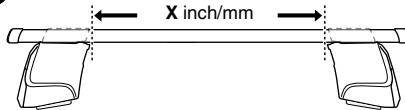

2

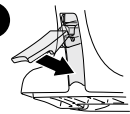

	X inch	X mm
BMW X1, 5-dr SUV, 10- (Without railing)	42"	1066 mm

1

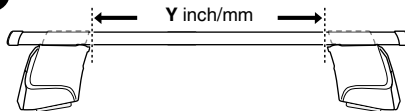

2

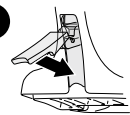

	Y inch	Y mm
BMW X1, 5-dr SUV, 10- (Without railing)	41 ⁵ / ₈ "	1056 mm

4



480R Rapid Traverse
754 Rapid System



480 Traverse

BMW X1, 5-dr SUV, 10- (Without railing)

204

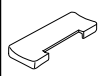

1106

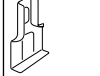

206

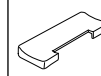

1106

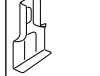

162

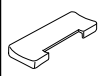

1106

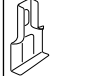

162

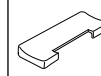

1106

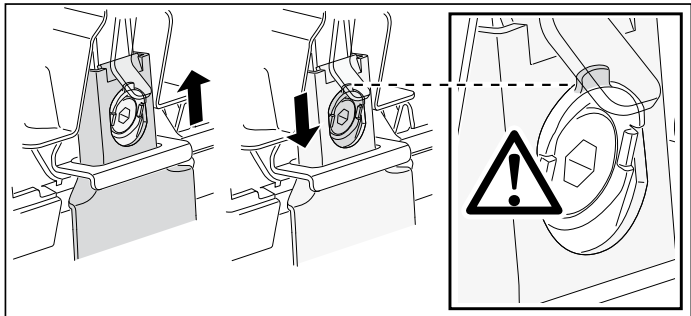
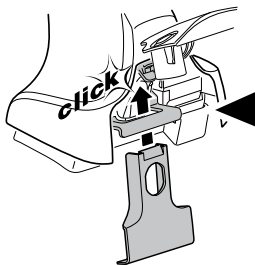
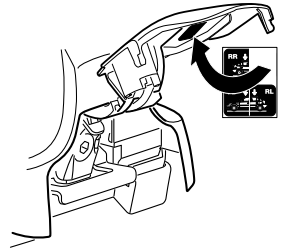
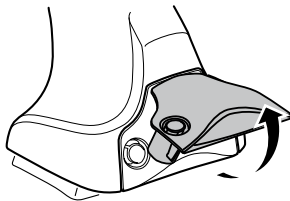
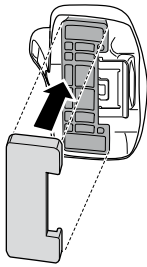
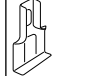

5

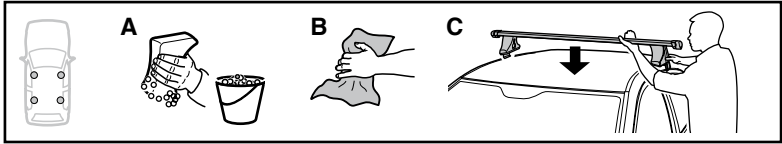

	X mm	Y mm	X inch	Y inch
BMW X1, 5-dr SUV, 10- (Without railing)	310 mm	700 mm	12 1/4"	27 1/2"

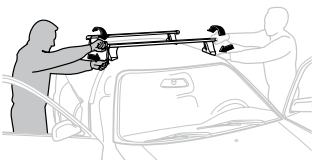
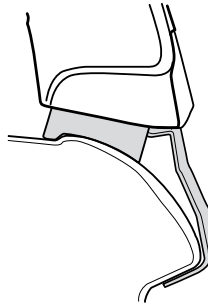
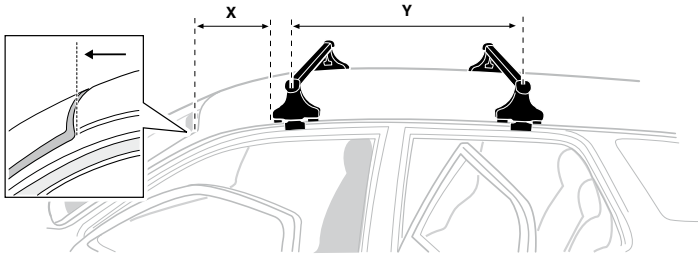

GB/US Tighten alternately

D Die Schrauben abwechselnd anziehen

F Serrer alternativement chaque côté

NL Afwisselend aan de linker- en de rechterkant aandraaien

I Alternare il serraggio delle viti

E Apretar alternativamente

PT Aperte alternadamente

S Dra åt växelvis

FIN Kierrä vuorotellen

EST Pinguldage vaheldumisi

LAT Pieļieciet pamāšus

LIT Užsukinkite pakaitomis

PL Śruby dokręcaj naprzemiennie

RU Затягивайте попеременно

CZ Pokrétla bagażníka dokręcaj dokręcaj naprzemiennie.

SK Dotahujte striedavo

SLO Privijajte izmenično.

HR Naizmjenično zategnite

HU Egy mástól függetlenül szorítandó

GR Σφιγχετε εναλλάξ

TR Dönüşümlü sıkın

中文 交替拧紧

한국어 번갈아 가며 조이십시오.

日本語 交互に締め付けてください。

ไทย ชนในแบบสลับ

6

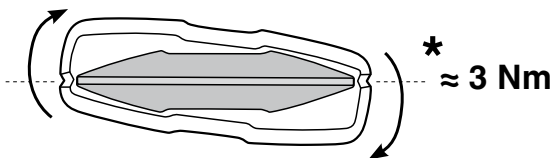
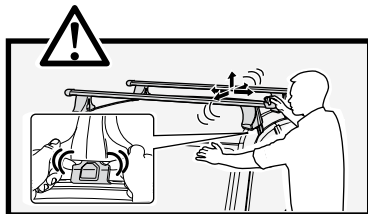
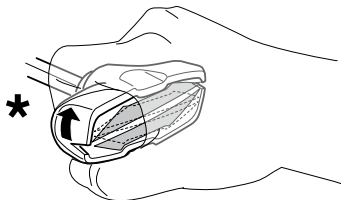
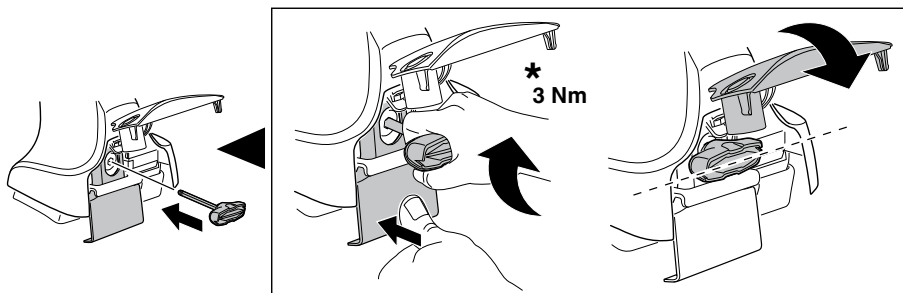
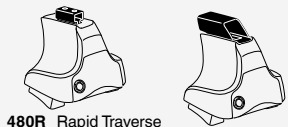

7

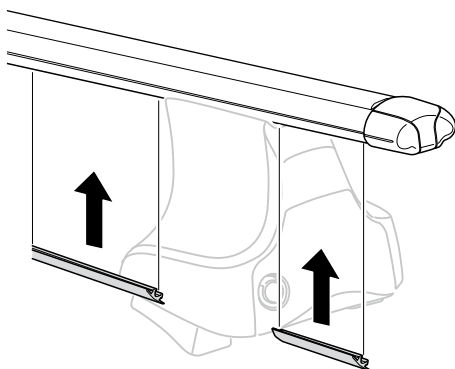
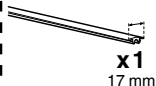

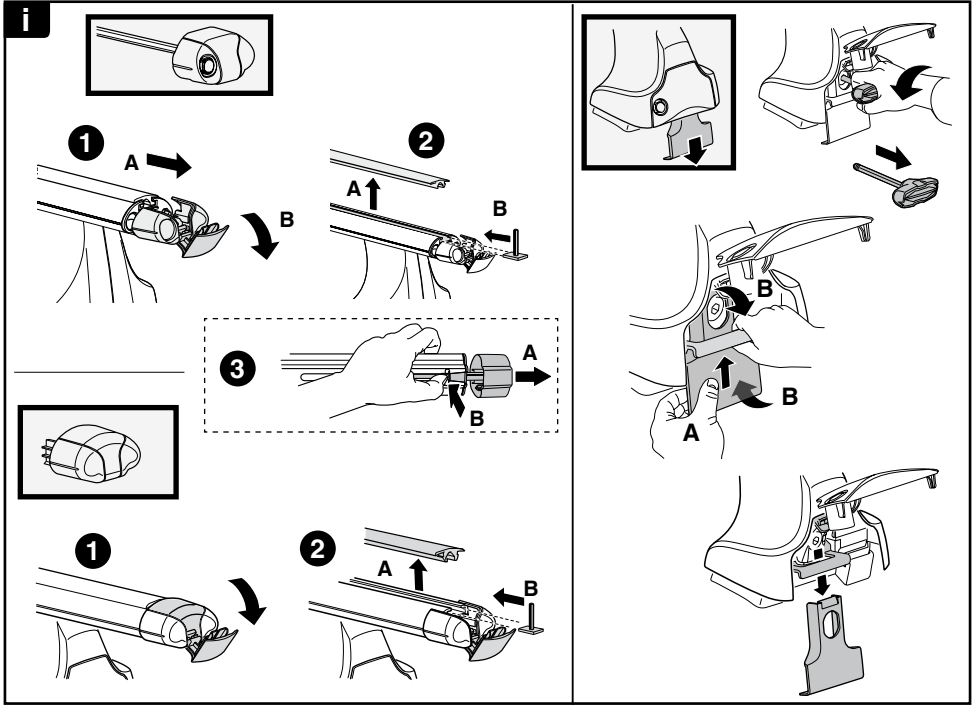
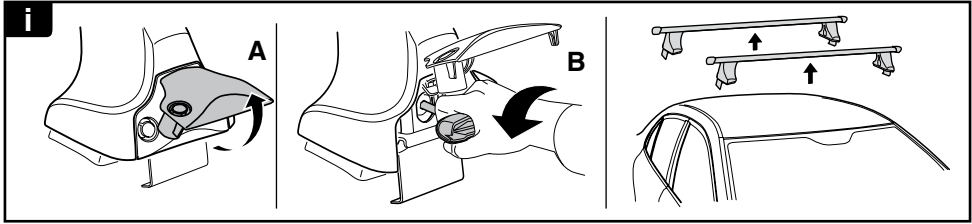

THULE
SWEDEN
**ONE
KEY
SYSTEM**

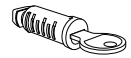
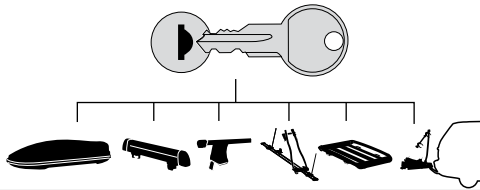

544 (x4)
596 (x6)
588 (x8)
510 (x10)
452 (x12)

NA
EUR
ASIA

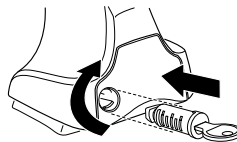

WW ▶ Thule Sweden AB, Box 69, 330 33 Hillerstorp, SWEDEN
NA ▶ Thule Inc., 42 Silvermine Road, Seymour, Connecticut 06483, USA

info@thule.com
customer.service@thule.com

www.thule.com

503-1602