

Kit 1514

HYUNDAI i20, 3-dr Hatchback, 09–
HYUNDAI i20, 5-dr Hatchback, 09–

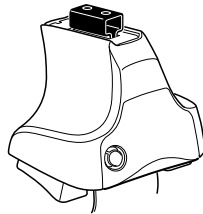

754 Rapid System
480R Rapid Traverse (North America)

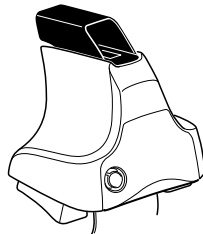
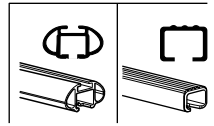

480 Traverse (North America)

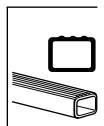

1



2



754 Rapid System
480R Rapid Traverse
(North America)

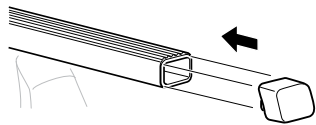
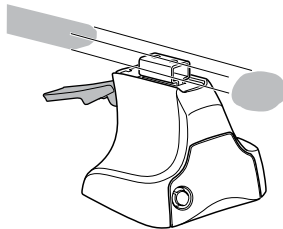

x4

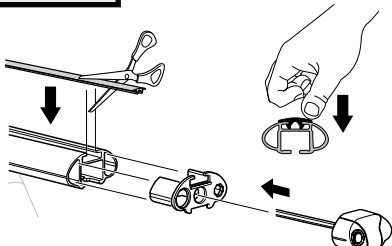
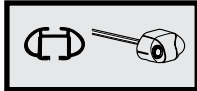

x4

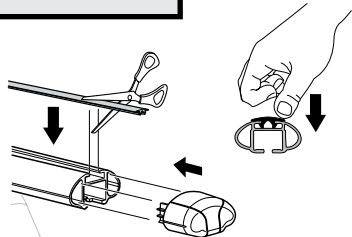
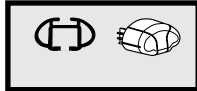

x4

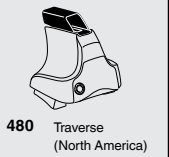

480 Traverse
(North America)

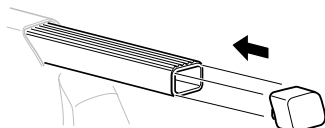
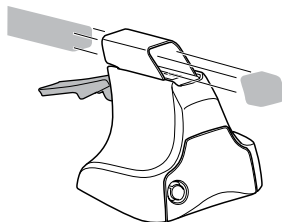

x4

3



754 Rapid System



	X
HYUNDAI i20, 3-dr Hatchback, 09–	33
HYUNDAI i20, 5-dr Hatchback, 09–	33



	Y
HYUNDAI i20, 3-dr Hatchback, 09–	29
HYUNDAI i20, 5-dr Hatchback, 09–	29

3



480R Rapid Traverse



480 Traverse

(North America)

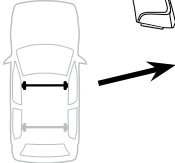

	X inch	X mm
HYUNDAI i20, 3-dr Hatchback, 09–	38 ⁵/₈ "	981 mm
HYUNDAI i20, 5-dr Hatchback, 09–	38 ⁵/₈ "	981 mm

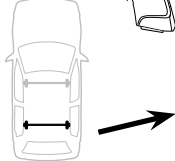

	Y inch	Y mm
HYUNDAI i20, 3-dr Hatchback, 09–	37 "	941 mm
HYUNDAI i20, 5-dr Hatchback, 09–	37 "	941 mm

4

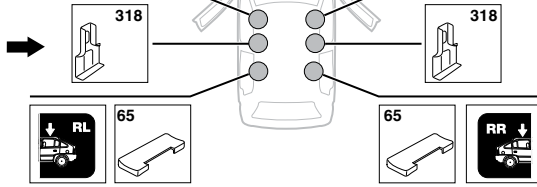
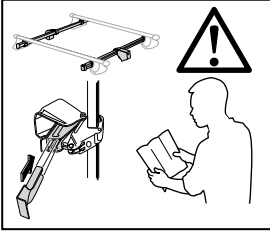
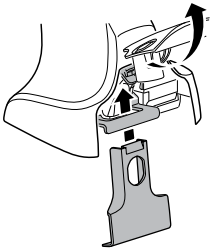
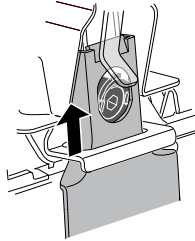
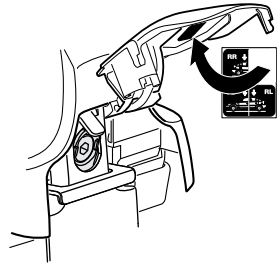
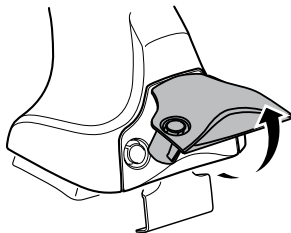
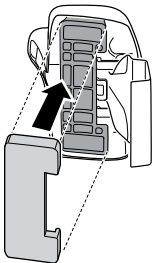
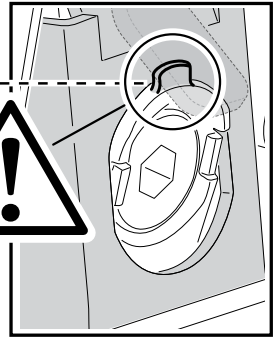
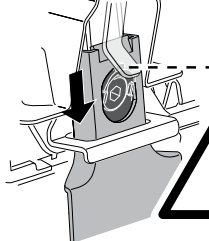

5**HYUNDAI i20, 3-dr Hatchback, 09–****SRA****HYUNDAI i20, 5-dr Hatchback, 09–****A****B****C**

6

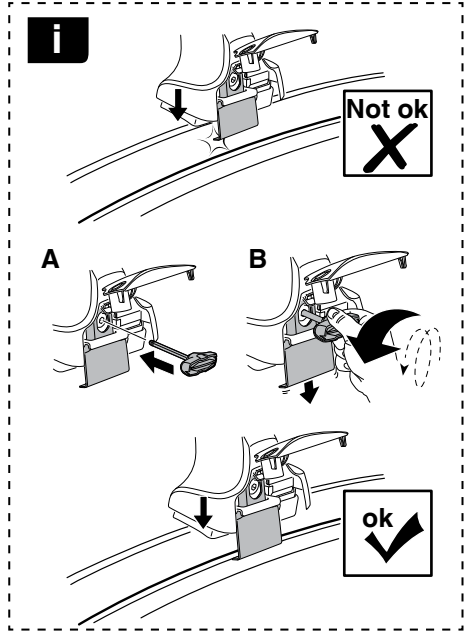

	X mm	Y mm	X inch	Y inch
HYUNDAI i20, 3-dr Hatchback, 09-	190 mm	670 mm	7 1/2"	26 3/8"
HYUNDAI i20, 5-dr Hatchback, 09-	190 mm	700 mm	7 1/2"	27 1/2"

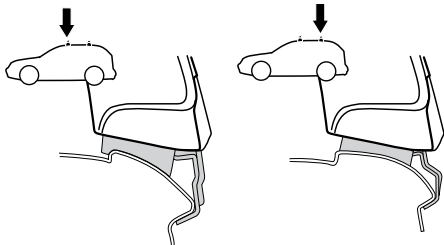
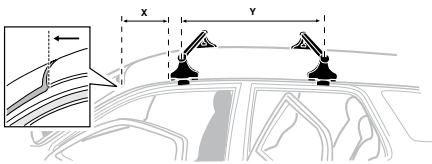

HYUNDAI i20, 3-dr Hatchback, 09-

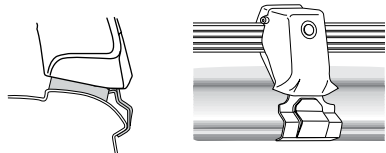
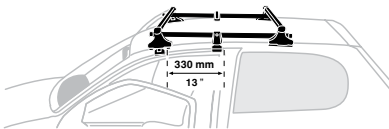

7

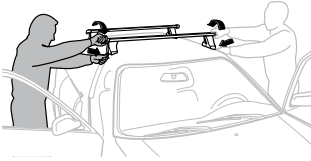

GB/US Tighten alternately
D Die Schrauben abwechselnd anziehen
F Serrer alternativement chaque côté
NL Afwisselend aan de linker- en de rechterkant aandraaien
I Alternare il serraggio delle viti
E Apretar alternativamente
PT Aperte alternadamente
S Dra åt växelvis
FIN Kierrä vuorotellen
EST Pinguldage vaheldumisi
LAT Pievelciēt pamišus
LIT Užsukinėkite pakaitomis
PL Śruby dokręcaj naprzemiennie
RU Затягивайте попеременно

CZ Pokręťta bagazníka dokręcaj dokręcaj naprzemiennie.
SK Doťahujte striedavo
SLO Privijajte izmenično.
HR Naizmjenično zategnite
HU Egymástól függetlenül szorítandó
GR Σφιγγεται εναλλάξ
TR Dönüşümlü sıkın

中文 交替拧紧

한국어 번갈아 가며 조이십시오.

日本語 交互に締め付けてください。

ไทย ชั้ในแบบสลับ

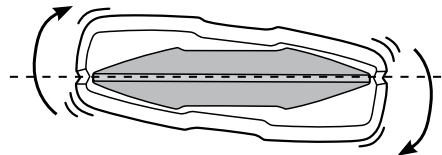
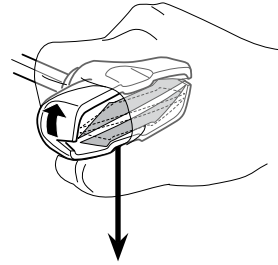
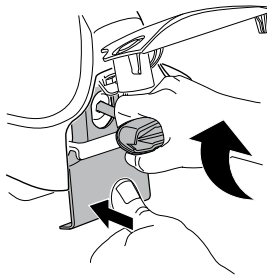
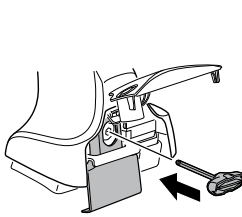

≈ 3 Nm

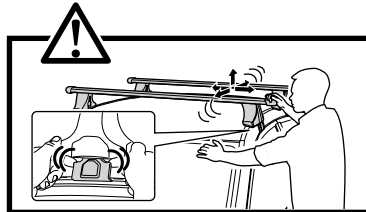
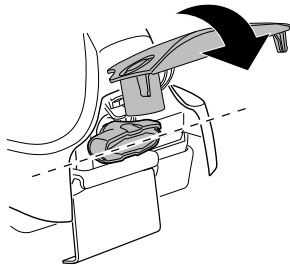

8



x1
17 mm

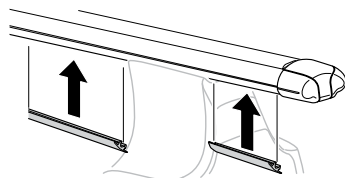

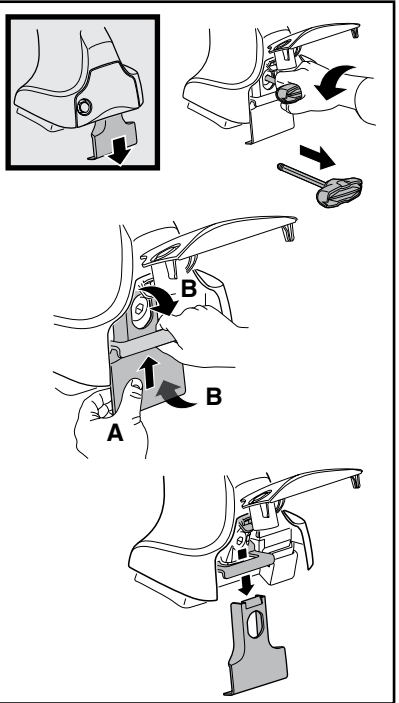
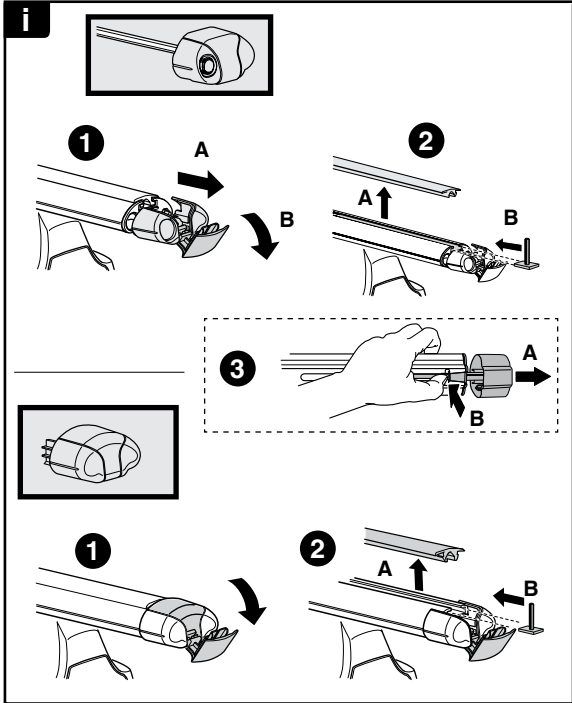

THULE
SWEDEN
**ONE
KEY
SYSTEM**

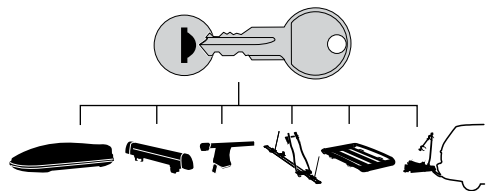

		(x4)
		(x6)
		(x8)
NA		(x10)
EUR		(x12)
ASIA		

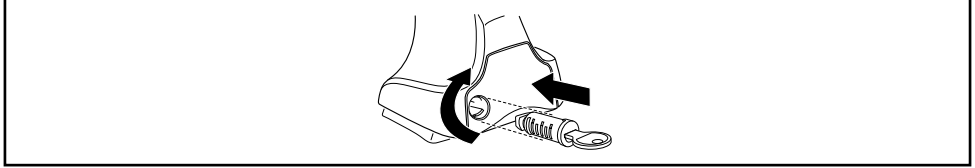

WW ▶ Thule Sweden AB, Box 69, 330 33 Hillerstorp, SWEDEN
NA ▶ Thule Inc., 42 Silvermine Road, Seymour, Connecticut 06483, USA

info@thule.com
customer.service@thule.com

www.thule.com