

Kit 1478

HYUNDAI I30 CW, 5-dr Estate, 08-*

* Without railing

480R
754

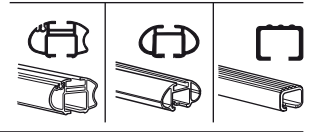
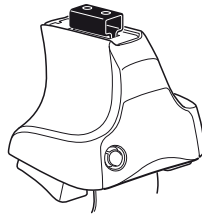

480

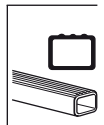
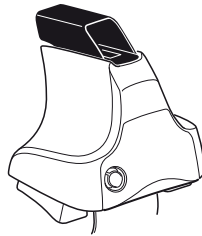

750

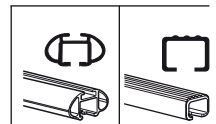
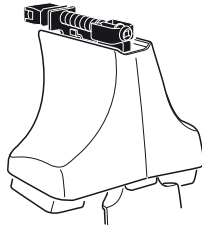

x2	x2	x2	x2	x2
x2		x2	x2	
x2		x4	x4	
x4				

958 x 4
 65 x 4
 x 1

Kit

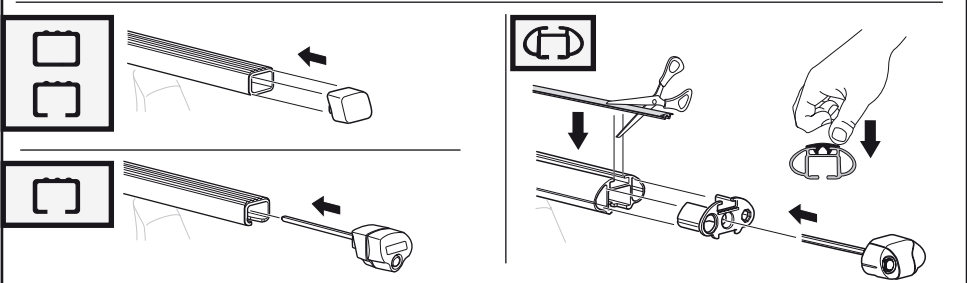
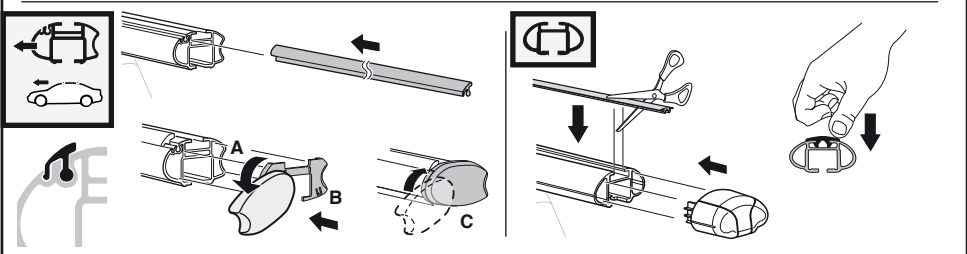
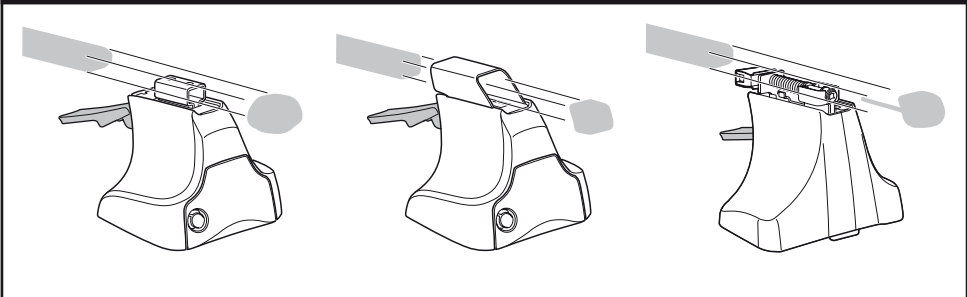
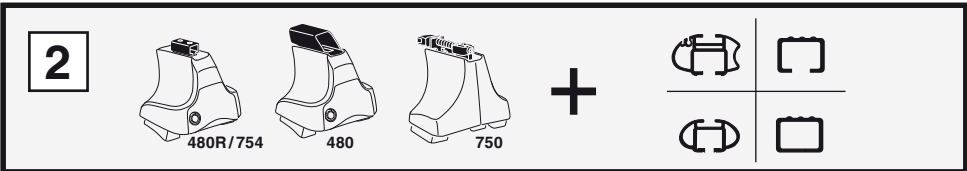
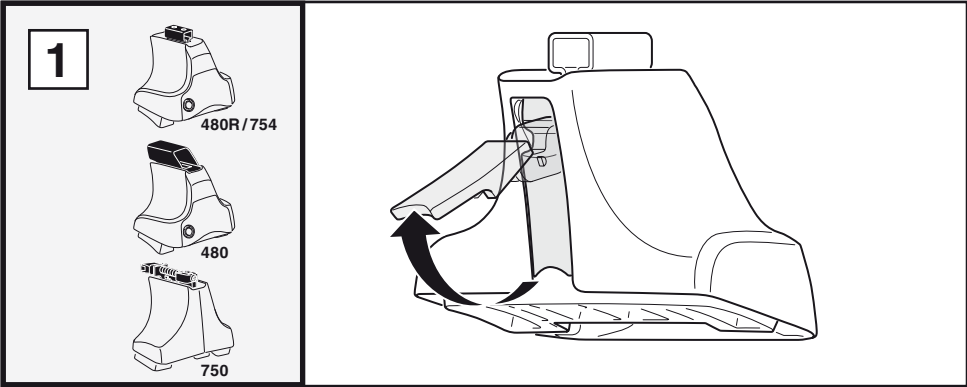

3

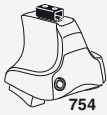

754

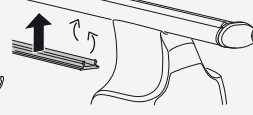
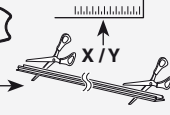

750



1

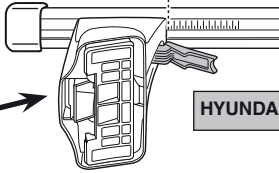
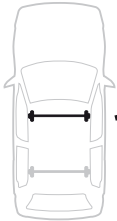

2

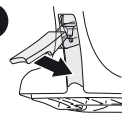

HYUNDAI I30 CW, 5-dr Estate, 08-

X
32,5

1

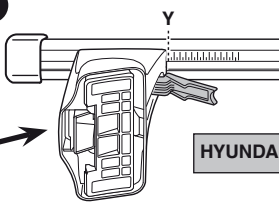

2

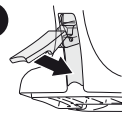

HYUNDAI I30 CW, 5-dr Estate, 08-

Y
30,5



480R



480

1

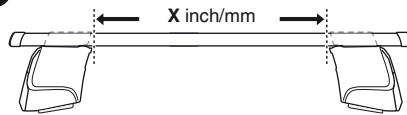

2

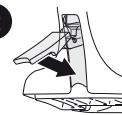

HYUNDAI I30 CW, 5-dr Estate, 08-

X inch | **X mm**
38 ³/₈" | 976 mm

1

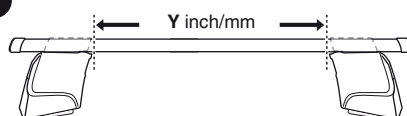

2

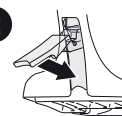

HYUNDAI I30 CW, 5-dr Estate, 08-

Y inch | **Y mm**
37 ⁵/₈" | 956 mm

4

HYUNDAI I30 CW, 5-dr Estate, 08-

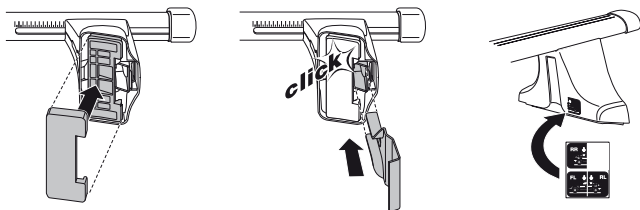
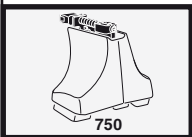
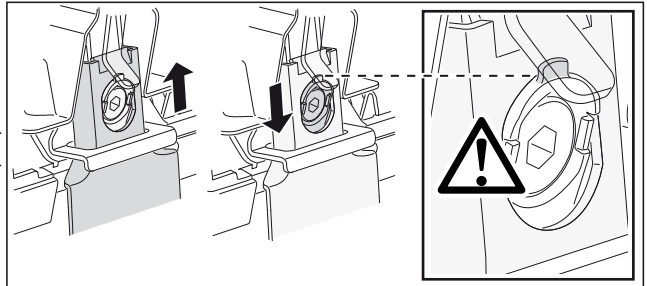
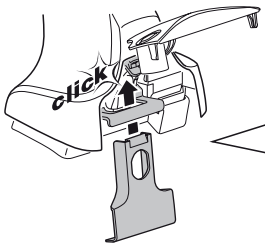
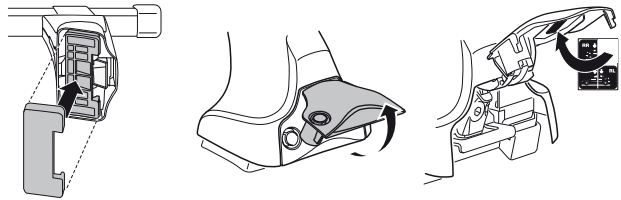
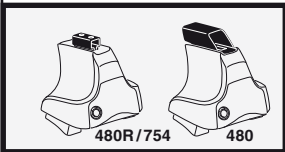
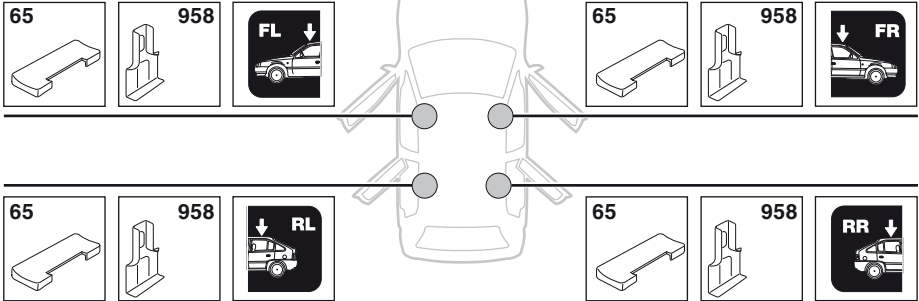

5

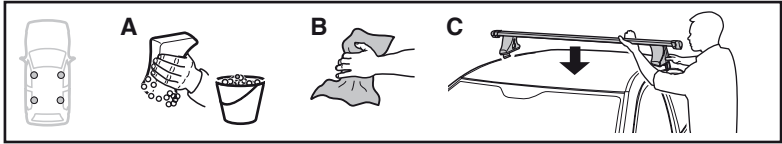

	X mm	Y mm	X inch	Y inch
HYUNDAI I30 CW, 5-dr Estate, 08-	450 mm	740 mm	17 ³ / ₄ "	29 ¹ / ₈ "

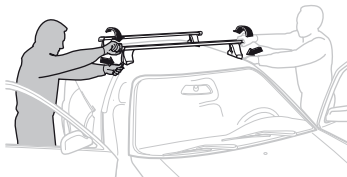
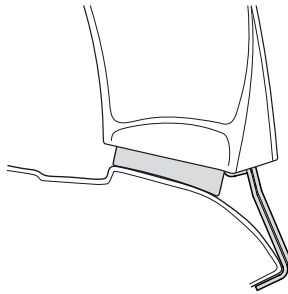
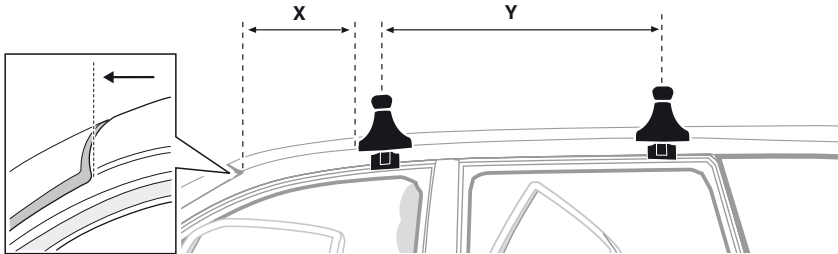

GB/US Tighten alternately

D Die Schrauben abwechselnd anziehen

F Serrer alternativement chaque côté

NL Afwisselend aan de linker- en de rechterkant aandraaien

I Alternare il serraggio delle viti

E Apretar alternativamente

PT Aperte alternadamente

S Dra åt växelvis

FIN Kierrä vuorotellen

EST Pinguldage vaheldumisi

LAT Pielveiciet pamišus

LIT Užsukinėkite pakaitomis

PL Śruby dokręcaj naprzemiennie

RU Затягивайте попеременно

CZ Pokręťta багаžníka dokręcaj dokręcaj naprzemiennie.

SK Doťahujte striedavo

SLO Privijajte izmenično.

HR Naizmjenično zategnite

HU Egymástól függetlenül szorítandó

GR Σφιγγετε εναλλάξ

TR Dönüşümlü sıkın

中文 交替拧紧

한국어 번갈아 가며 조이십시오.

日本語 交互に締め付けてください。

ไทย ชันโนแบบสลับ

6



480R/754



480

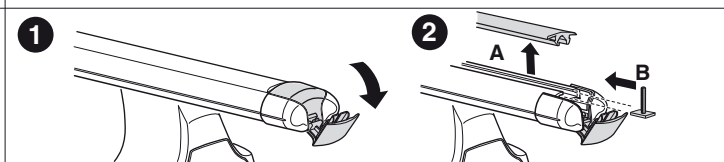
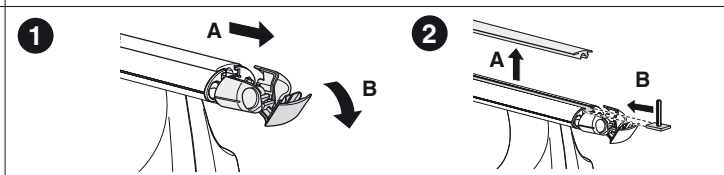
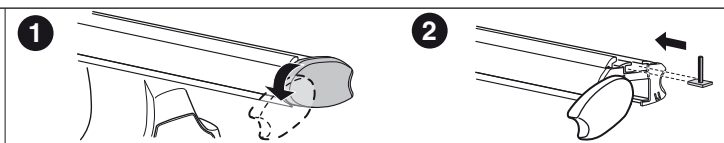
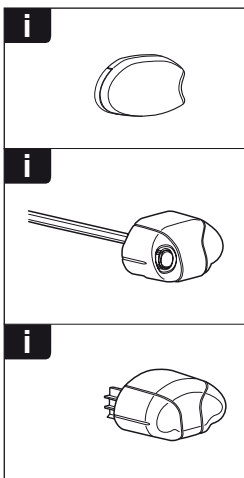
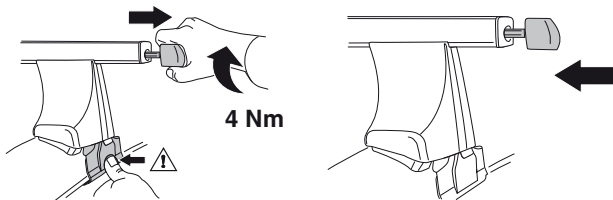
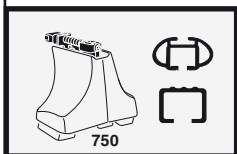
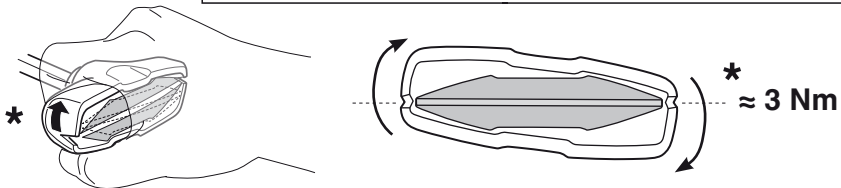
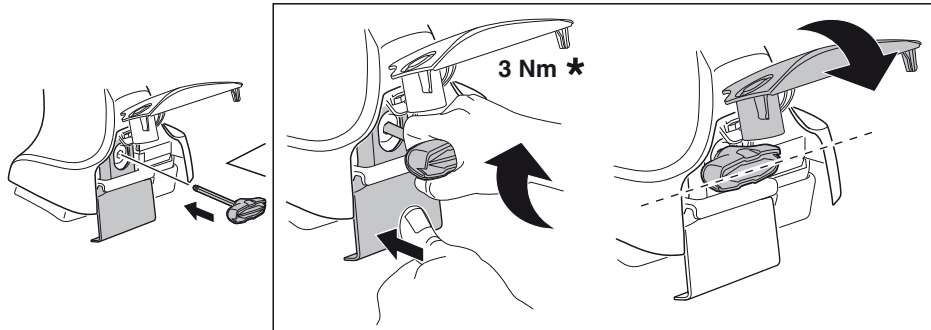

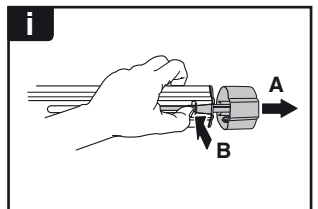
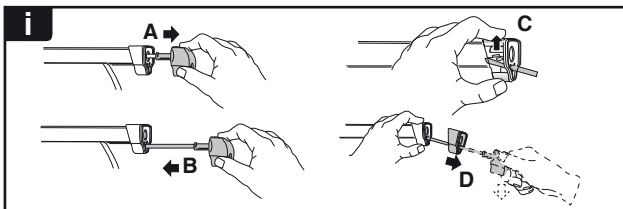
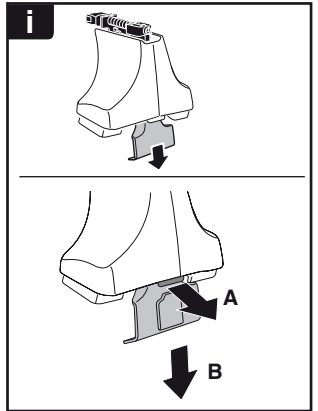
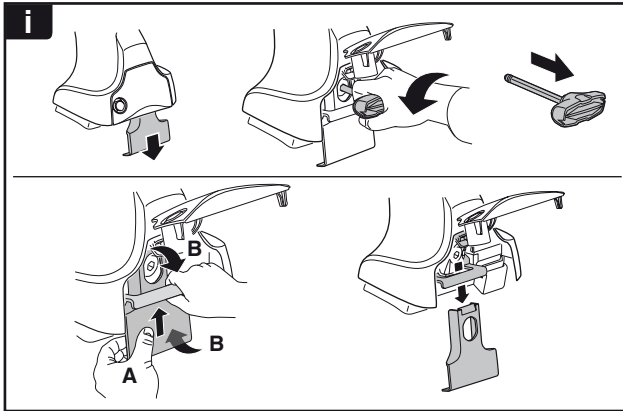
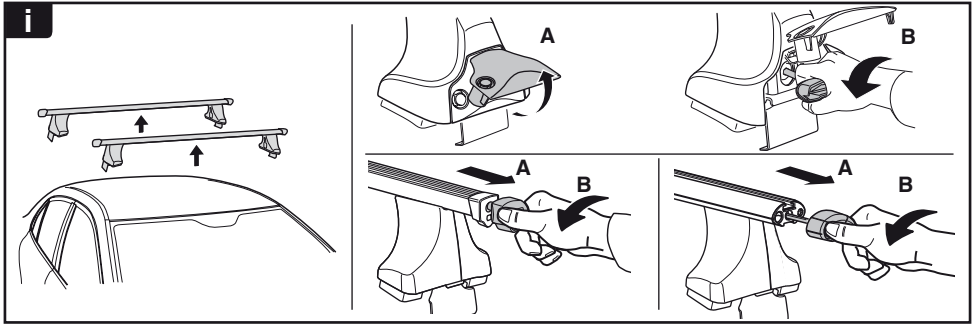

THULE
SWEDEN
**ONE
KEY
SYSTEM**

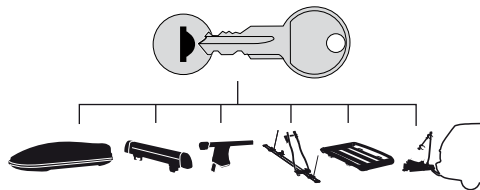

		(x4)
		(x6)
		(x8)
NA		(x10)
EUR		(x12)
ASIA		(x12)

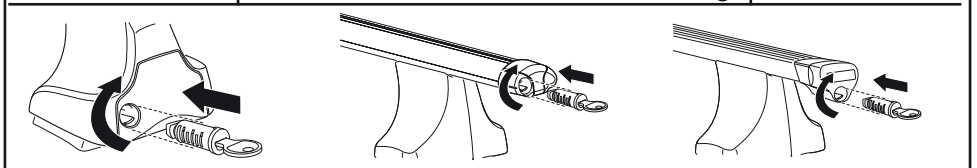

WW ▶ Thule Sweden AB, Box 69, 330 33 Hillerstorp, SWEDEN
NA ▶ Thule Inc., 42 Silvermine Road, Seymour, Connecticut 06483, USA

info@thule.com
customer.service@thule.com

www.thule.com